



2" x 4" x 1.18"

General Specifications:

Input voltage 90 VAC to 264 VAC
 Input frequency 47 Hz to 63 Hz
 Inrush current < 30/60A at 115/230VAC
 Hold up time 16ms
 Over load/Short circuit protection auto recovery
 Over voltage protection latch off
 Operating temperature -40°C to 70°C
 derating: 2.5% / °C > 50°C for convection cooling
 Storage temperature -40°C to +85°C

Features:

- Peak load (1.5 x rated current, Vo=rated for 5 sec)
- Design for BF application
- Convection cooling for Rated power
- No load < 0.3W
- (-A) for no burst sound
- (-H) for home healthcare application
- -40°C to +70°C operating temperature
- 5,000m operation altitude

Applications:

- For peak load applications, such as motor drive, coffee machine, vending machine, gaming machine, and other industrials.
- For input class II and EMI class B application, such as home healthcare device, and other medical devices.

EMI EN55011 "B", EN61000-3-3
 Harmonics.....EN61000-3-2, class A
 EMS..... EN61000-4-2,-3,-4,-5,-6,-8,-11
 SafetyUL/CSA 60950-1, 2nd Ed., EN 62368-1, 2nd Ed.
 ANSI/AMMI/CSA/EN60601-1, 3.1 Ed.
 CB report, CE mark, RM report/file
 Energy Saving ENERGY STAR
 for computers version 6.0
 for displays version 6.0
 ErP regulation EC(No) 1275/2008

Mechanical Specifications:

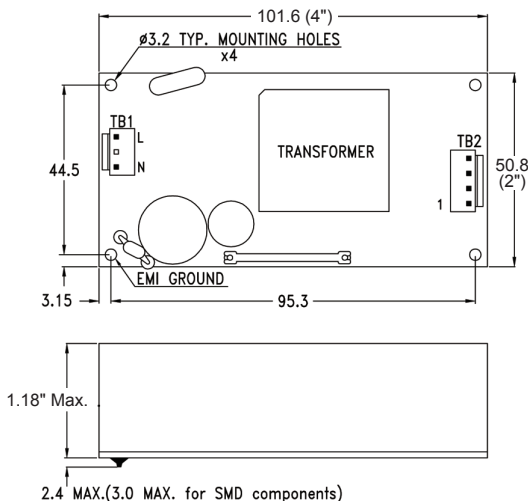

Notes:

1. Size:
2" x 4" x 1.18"
2. Mounting Hole:
44.5 x 95.3 (mm)
3. Connectors:
AC input: JST B2P3-VH or Molex 5277-02A or equivalent
DC output: JST B4P-VH or Molex 5273-04A or equivalent
4. Output Pin assignment:

1	2	3	4
Vo	Vo	GND	GND

5. Packing:
Net weight: 160 g approx. / unit
Gross weight: 15 kg approx. / carton, 80 units / carton
Carton size (mm): 382 (L) x 374 (W) x 277 (H)

-Jim-

10 years Warranty (contact Skynet's Distributors for details)

Output Specifications:

MODEL NO.	OUTPUT RAIL	LOAD				INITIAL ACCURACY	EFFICIENCY @ 100% LOAD
		MIN.	RATED	MAX.	PEAK		
SNP-HF87 SNP-HF87-A SNP-HF87-H	+12V	0A	6.66A	7.5A	9A	+11.8V~+12.2V	87% 83%
SNP-HF88 SNP-HF88-A SNP-HF88-H	+15V	0A	5.33A	6.66A	8A	+14.8V~+15.2V	87% 86%
SNP-HF89 SNP-HF89-A SNP-HF89-H	+24V	0A	3.33A	4.6A	5.3A	+23.8V~+24.2V	87% 86%
SNP-HF8T SNP-HF8T-A SNP-HF8T-H	+48V	0A	1.67A	2.1A	2.71A	+47.5V~+48.5V	87% 86%

Note:

- Standby Power Consumption with System:**
For computers and displays, ENERGY STAR in U.S. and ErP regulation in Europe require the input power should be less than 0.5W at standby mode.
- Output Load:**
80W for convection cooling; 100W for forced air cooling.
- Peak Load Duration:**
Peak 120W can last for 5 sec.
- Isolation Grade:**
Primary ↔ Ground : 1MOPP (1500Vac)
Primary ↔ Secondary : 2MOPP (4000Vac)
Secondary ↔ Ground : 1MOPP (1500Vac)
- Leakage Current:**
Earth leakage current < 300uA
Touch current < 100uA
- EMI Grounding:**
If there is a metal sheet under the power supply, connect the EMI ground to that metal sheet.
- Model Selection:**
Most of power supplies will create audible burst sound at light load, if the application wants to meet input power < 0.5W at standby mode.
SNP-HF8x is for ITE & Medical applications which require standby mode.
SNP-HF8x-A is for ITE & Medical applications but without burst sound and no standby mode.
SNP-HF8x-H is for Home Healthcare application, input class II and EMI class B.
- The safety application will be proceeded upon request.

-Jim-

Performance for SNP-HF87-A:

1. Switching frequency ripple

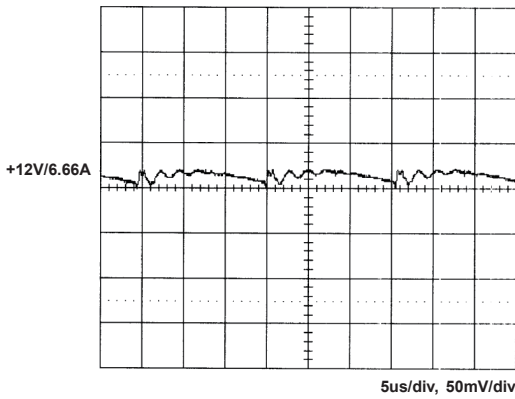

2. Line frequency ripple

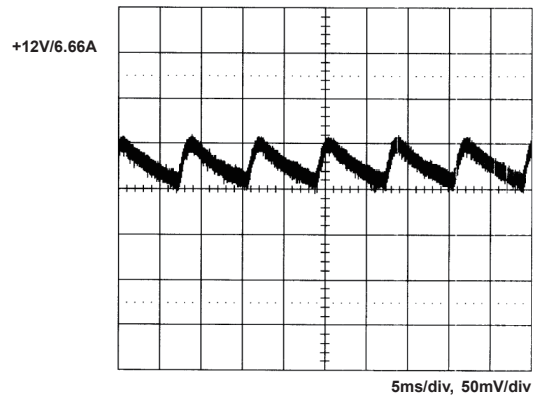

3. Output turn on wave form

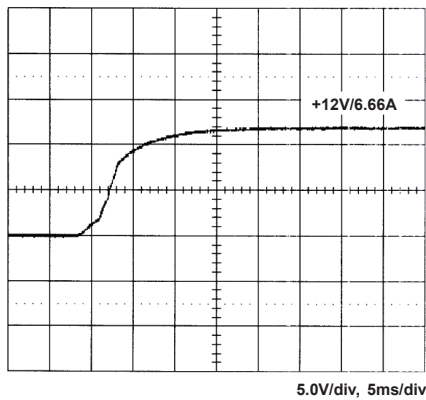

4. Output turn off wave form

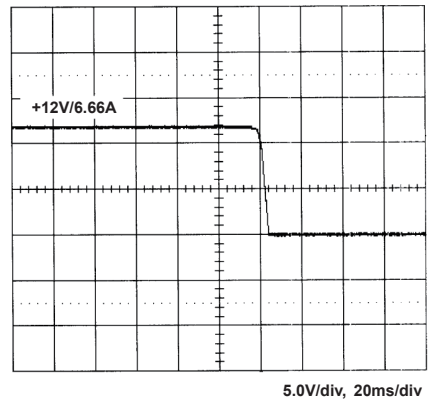

5. Hold-up time

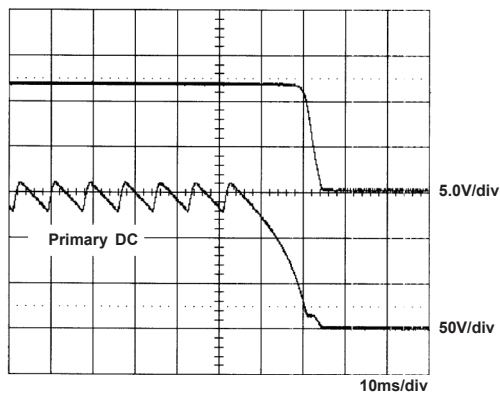

6. Over voltage protection

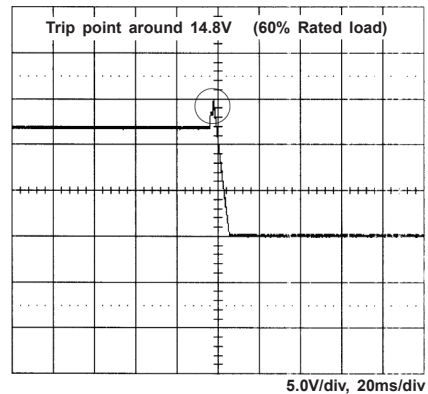

7. FCC B Class I

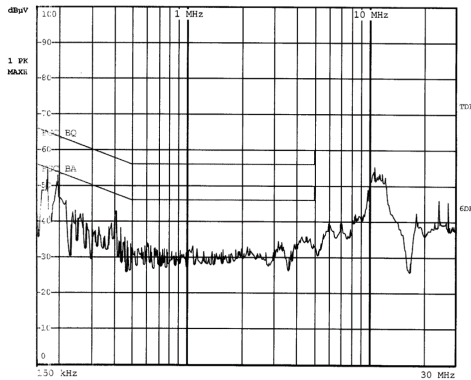

8. EN55011 22 B Class I

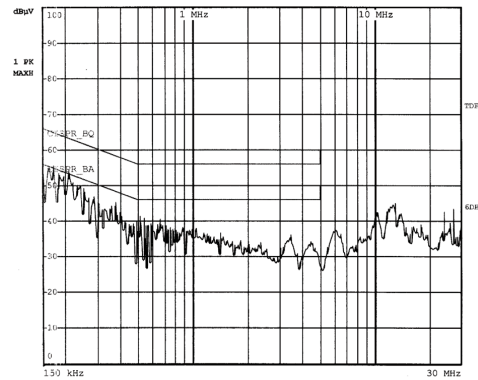

9. FCC B Class II

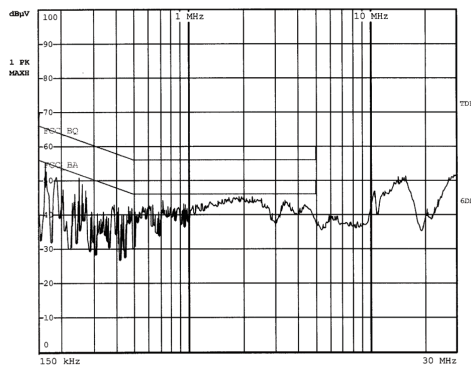

10. EN55011 22 B Class II

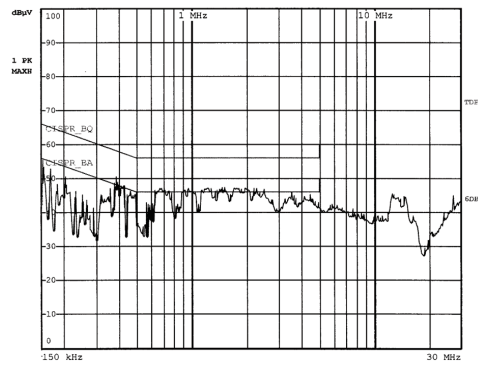

11. Power derating curve

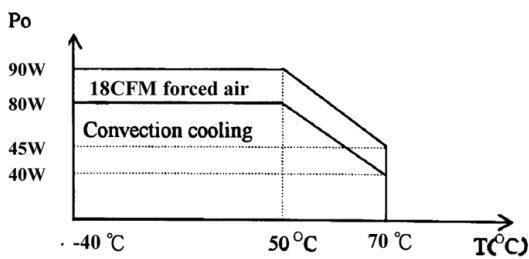

12. Torque capability

