

SNP-HF69 SPECIFICATION

SPECIFICATION

For

SWITCHING POWER SUPPLY

- **SNP-HF69**
- **SNP-HF69-A**
- **SNP-HF69-H**

STANDARD PRODUCT

All Rights Reserved

Reviewed by Product Engineer	Jm 1-6-11					
Typed by Document Assistant	董瑞英 010621					
SKYNET ELECTRONIC		LAST REV. NO.				

1.0 INTRODUCTIONS

SNP-HF69 series is an open frame 60W power supply with built-in:

- (1) Peak load (1.5 x rated current, V_o =rated for 5 sec)
- (2) Meet 2 x MOPP, Earth leakage current < 300uA and Touch current < 100uA for BF application
- (3) SNP-HF69 is with no load <0.3W green power feature, input class I
- (4) SNP-HF69-A is without burst sound, input class I
- (5) SNP-HF69-H is for home healthcare application, input class II and EMI class B
- (6) -40°C to +70°C operating temperature
- (7) 5,000m operation altitude

2.0 INPUT SPECIFICATIONS

2.1 Input voltage

Input voltage range : 90Vac to 264Vac

Nominal line voltage : 115Vac/230Vac

2.2 Input frequency

47Hz to 63Hz

2.3 Input current

$3A_{rms}$ max/115Vac, $1.5A_{rms}$ max/230Vac

2.4 Inrush current

30A max/115Vac, 60A max/230Vac (EMI capacitors excluded, cold start at 25°C)

3.0 OUTPUT SPECIFICATIONS

All specs under item 3.0 except with special notes are defined and tested at nominal line input, rated load and 25°C

3.1 Load range

V_o	min. load	rated load	max load	peak load
+24V	0A	2.5A	3.33A	3.75A

3.1.1 Factory adjustment

+23.8V to +24.2V (60% rated load, 115Vac)

3.1.2 Peak load max duration

5sec. (duty cycle < 50%, average power < rated power)

3.1.3 Cooling

Rated load for convection cooling ; max load for 18 CFM forced air cooling.

3.2 Ripple and noise

< 1% (20MHz bandwidth limited, 1X probe with 0.47uF parallel capacitor)

3.3 Line regulation

< ±0.5% (90Vac to 264Vac, compare with 115Vac)

3.4 Load regulation

< ±1% (20% to 100% rated load, compare with 60% rated load)

3.5 Capacitive load start-up

< 8,000uF

4.0 GENERAL FEATURES

All specs under item 4.0 except with special notes are defined and tested at nominal line input, rated load and 25°C

4.1 Efficiency

SNP-HF69

>86% at 100% rated load

SNP-HF69-A & SNP-HF69-H

>85% at 100% rated load

4.2 Hold up time

16 ms typical

4.3 No load input power

<0.3W for SNP-HF69.

<2W for SNP-HF69-A & SNP-HF69-H, skip burst mode for preventing audible noise.

4.4 Protection

4.4.1 Over-voltage protection

Trip point : +27V to +30V

Protection mode : Latch-off

4.4.2 Short circuit and over-load protection

Protection mode : Auto-recovery

5.0 ENVIRONMENT SPECIFICATIONS

5.1 Operating temperature

-40°C to 70°C

(For both rated and max load. output load derates linearly to 50% from 50°C to 70°C)

(Rated load with convection cooling; max load with 18 CFM forced air cooling)

Output derating curve

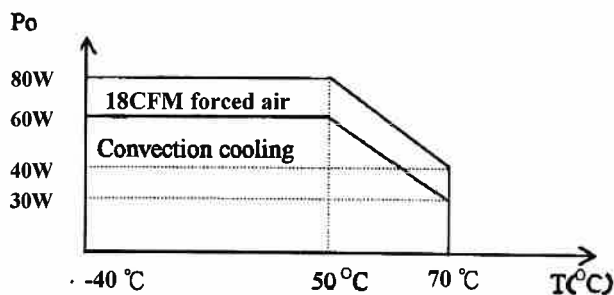

Max load fan location

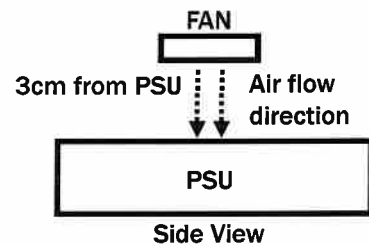

5.2 Storage temperature

-40°C to 85°C

5.3 Operating humidity

5% to 95% RH, non-condensing

5.4 Altitude

0 to 5000m

6.0 INTERNATIONAL STANDARDS

6.1 Safety standards

Label voltage: 100Vac to 240Vac

Designed to meet:

ITE:

UL 60950-1, 2nd Edition, 2014-10-14

CAN / CSA C22.2 No.60950-1-07 2nd Edition , 2014-10

IEC 60950-1:2005+A1+A2

EN 62368-1, 2nd edition

Medical:

3.1 Edition:

ANSI /AAMI ES60601-1(2005 / (R) 2012+A1:2012, C1:2009 / (R) 2012+A2:2010 / (R) 2012)

CAN/CSA-C22.2 No.60601-1:14

IEC 60601-1:2005+A1

EN 60601-1:2006+A11+A1+A12

3rd Edition:

ANSI /AAMI ES 60601-1(2005+C1:09+A2:10)

CAN/CSA-C22.2 No. 60601-1(2008)

IEC 60601-1:2005

EN 60601-1:2006+A11+A12

2nd Edition:

UL 60601-1 , 1st Edition

CAN/CSA-C22.2 No.601.1-M90,2005

IEC 60601-1:1988+A1+A2

EN 60601-1:1990+A1+A2+A13

6.2 EMI standards

FCC docket 20780 curve "B"

EN55022, level "B"

EN55011, level "B"

EN 61000-3-2 class "A"

EN 61000-3-3

6.3 EMS standards

EN61000-4-2	8kV/contact discharge, 15kV/air discharge	Criterion A
EN61000-4-3	10V/M with 80% AM	Criterion A
EN61000-4-4	2kV (100KHz)	Criterion A
EN61000-4-5	2kV/Line-Line, 4kV/Line-Earth	Criterion A
EN61000-4-6	10V with 80% AM	Criterion A
EN61000-4-8	30A/M	Criterion A
EN61000-4-11	100% dips 10ms,	Criterion A
	100% dips 20ms,	Criterion B
	30% dips 500ms,	Criterion A
	60% dips 200ms,	Criterion B
	100% dips 5000ms,	Criterion B

7.0 MECHANICAL SPECIFICATION

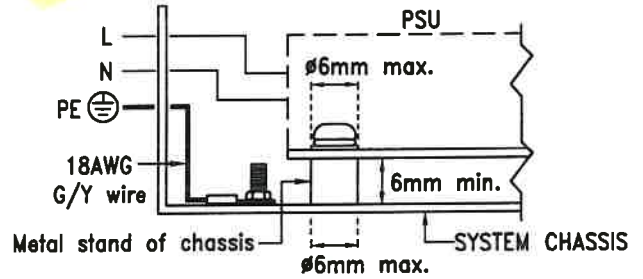
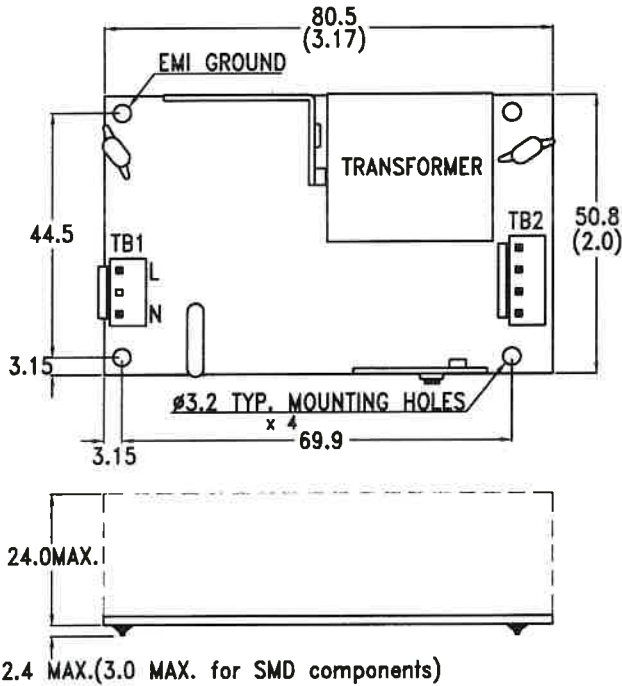

Note :

1. SNP-HF69 and SNP-HF69-A model have EMI GROUND. (It is designed for Class I system.)
2. The mounting hole with EMI GROUND is needed for metal stand for EMC purpose, Plastic spacer support for others are suitable to keep the safety spacing.

7.1 Dimensions

Dimensions shown in mm (inch) as above. Tolerance specified is +/-0.4mm (0.016 inch).

7.2 Connectors

TB1--AC Input : JST B2P3-VH or equivalent.

TB2--DC Output : JST B4P-VH or equivalent.

7.3 DC Output pin assignment

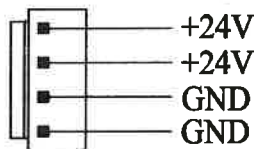

7.4 Packing

Net weight	:	114g approx. / unit
Carton size(mm)	:	437(L) x 402(W) x 240(H)
Quantity	:	100 units / carton
Gross weight	:	14.0kg approx. / carton

8.0 PERFORMANCE (input voltage is 115VAC, unless others specified)

8.1 Switching frequency ripple

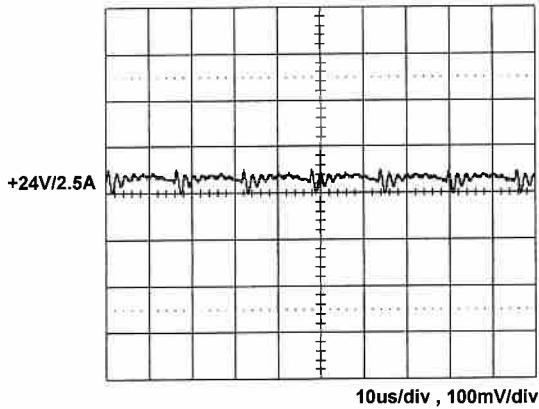

8.2 Line frequency ripple

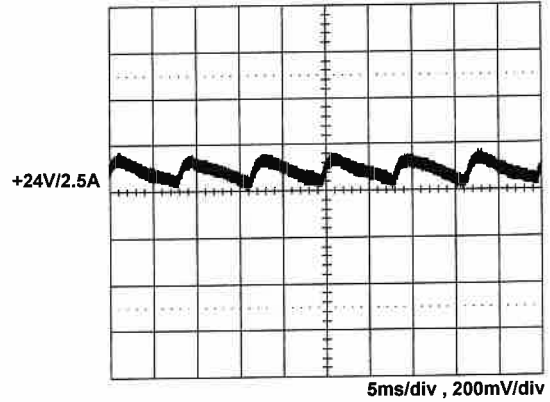

8.3 Output turn on wave form

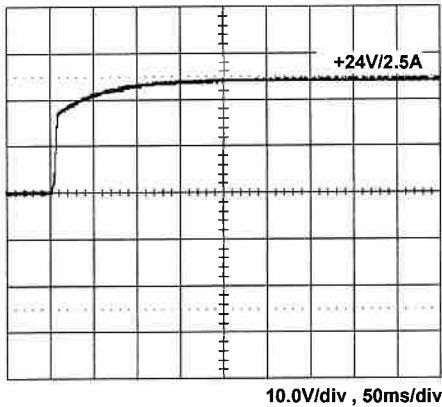

8.4 Output turn off wave form

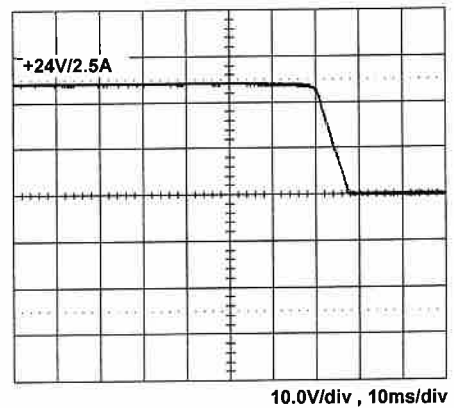

8.5 Hold-up time

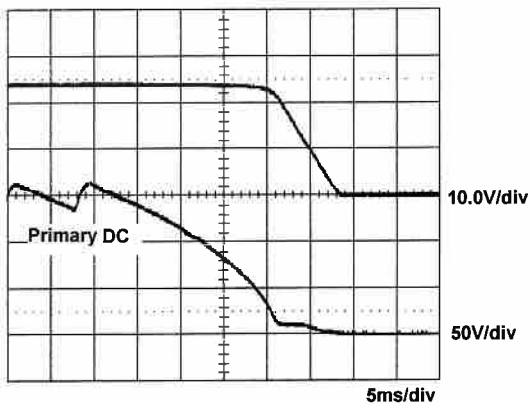

8.6 Over voltage protection

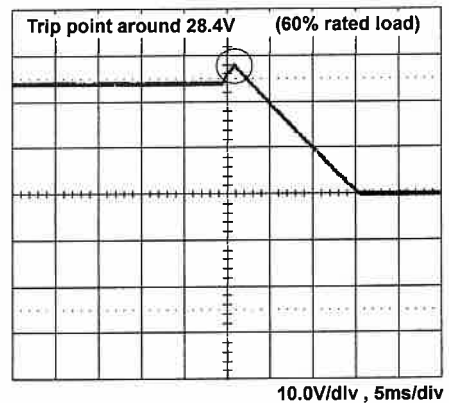

8.7 +24V Step response

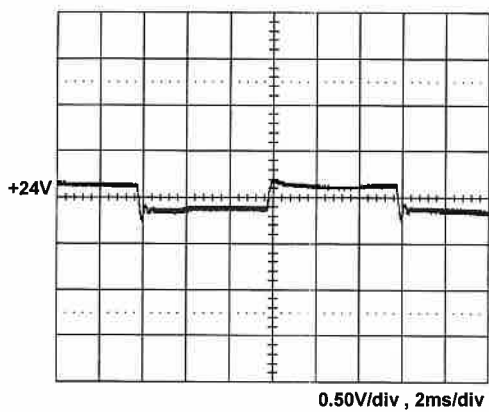

+24V step from 0.5A to 2.5A

8.8 FCC B performance class I

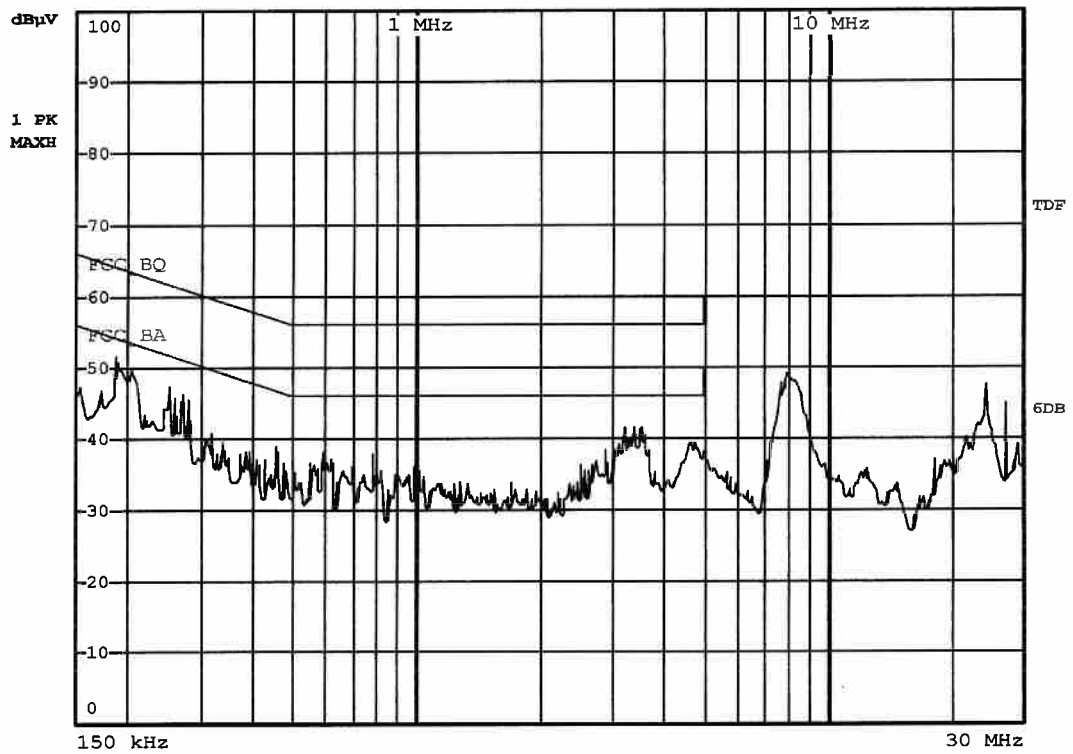

8.9 EN55011 22 "B" class I

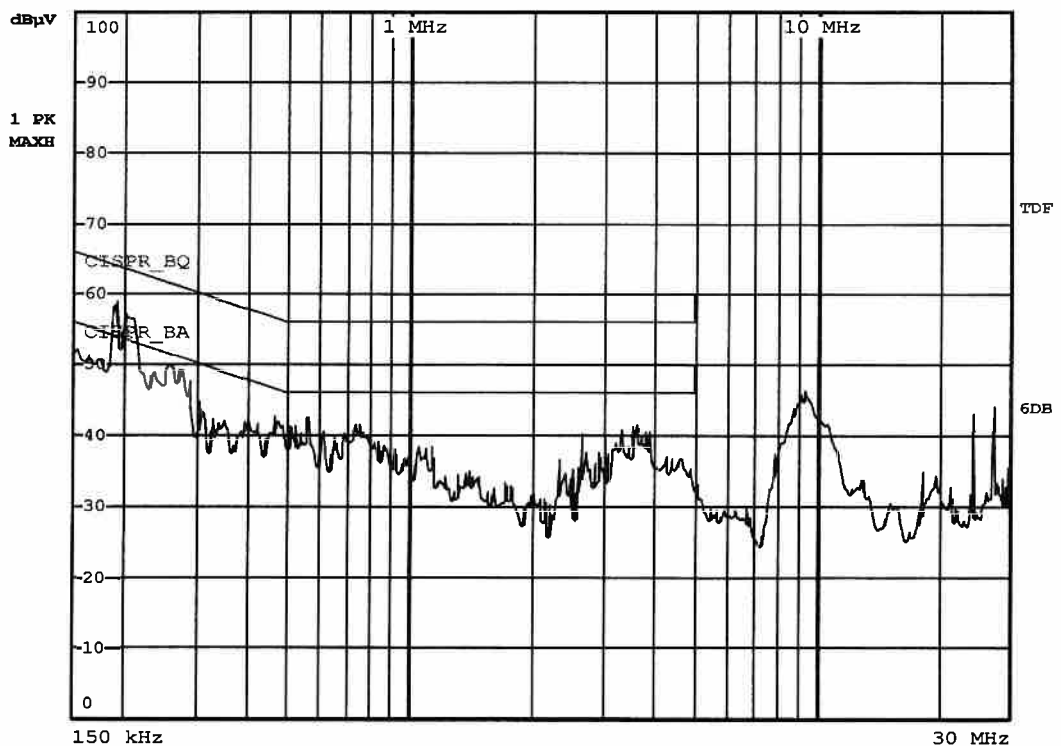

8.10 FCC B performance class II

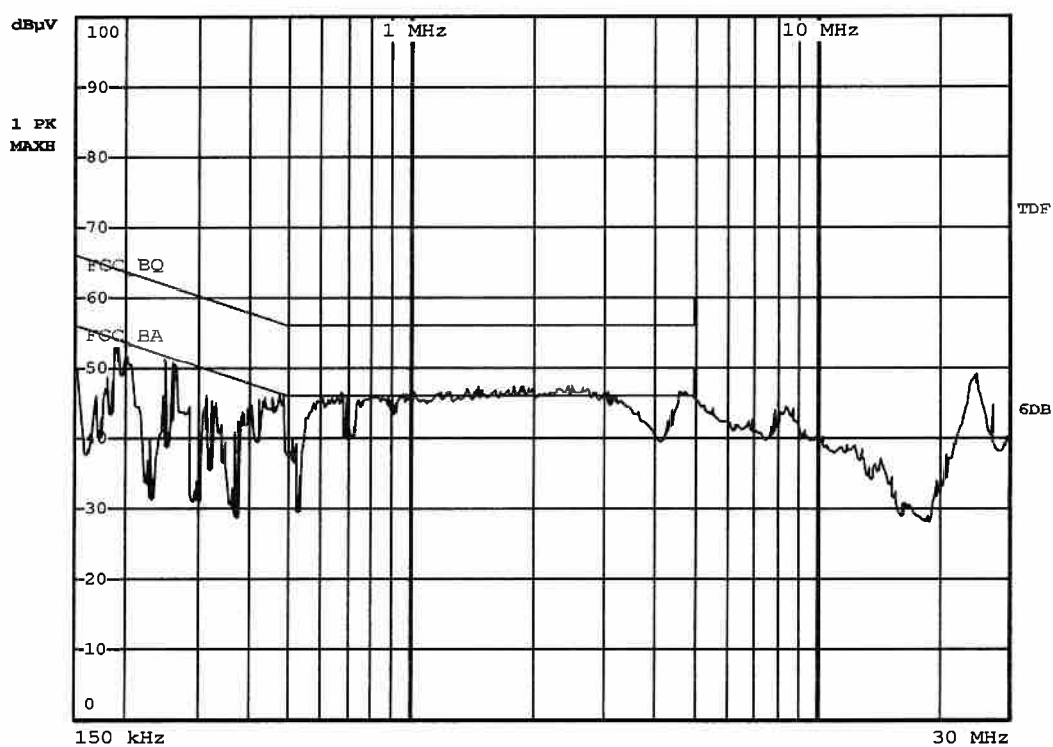

8.11 EN55011 22 "B" class II

