

SPECIFICATION

For

SWITCHING POWER SUPPLY

M/N : SNP-G209-U

STANDARD PRODUCT

All Rights Reserved

| | | | | | | |
|--------------------------------|---------------|----------------|---------------|--|--|--|
| Reviewed by Product Manager | Jim 1-7-11 | Jim 4-14-23 | | | | |
| Typed by Document Assistant | 蕭瑞英 010621 | 蕭瑞英 041423 | | | | |
| SKYNET ELECTRONIC | | | LAST REV. NO. | | | |

1.0 INTRODUCTIONS

SNP-G209-U is an open frame, general purpose and rated 200W SMPS. It also features in ITE safety and green power.

2.0 INPUT SPECIFICATIONS

2.1 Input Voltage

Input voltage range : 90Vac to 264Vac

Nominal line voltage : 115Vac/230Vac

2.2 Input frequency

47Hz to 63Hz

2.3 Input current

$4A_{rms}$ max/115Vac, $2A_{rms}$ max/230Vac

2.4 Inrush current

30A max/115Vac, 60A max/230Vac (EMI capacitors excluded, cold start at 25°C)

2.5 Test Condition

All specs except international standards or specs with special notes are defined and tested at nominal line input, rated load and 25°C.

3.0 OUTPUT SPECIFICATIONS

3.1 Load range

| Vo | min. load | rated load | max. load | peak load |
|------|-----------|------------|-----------|-----------|
| +24V | 0A | 8.4A | 12.5A | 16.7A |

3.1.1 Factory adjustment

+23.9V to +24.1V (60% rated load, 115Vac)

3.1.2 Peak load max duration

5sec. (duty cycle < 10%, average power < 200W)

3.1.3 Min load for FAN use

To use fan output (TB3), Vo should have 20W min load.

3.2 Ripple and noise

< 200mV (20MHz bandwidth limited, 1X probe with 0.47uF parallel capacitor)

3.3 Line regulation

< ±0.5% (90Vac to 264Vac, comparing with 115Vac)

3.4 Load regulation

< ±1% (20% to 100% rated load, comparing with 60% rated load)

3.5 Capacitive load start-up capability

< 7000uF

4.0 GENERAL FEATURES

4.1 Efficiency

Rated load efficiency : 91% typical

Average efficiency of 25%, 50%, 75% and 100% rated load : >87%

4.2 Hold up time

20ms typical

4.3 No load input power

<0.5W (without FAN connection)

4.4 Protection

4.4.1 Over-voltage protection

Trip point : +25.5V to +29.5V (60% rated load)

Protection mode : Latch-off

4.4.2 Short circuit and over-load protection

Protection mode : Auto-recovery

4.5 Remote sense

Compensates 0.5V lead drop max.

5.0 ENVIRONMENT SPECIFICATIONS

5.1 Operating temperature

-20°C to 70°C

(For both rated and max load. output load derates linearly to 50% from 50°C to 70°C)

(Rated load with convection cooling; max load with 18 CFM forced air cooling)

Output derating curve

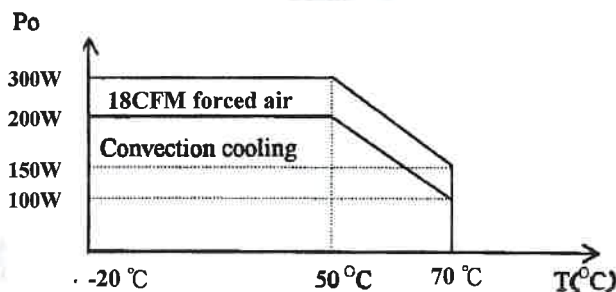

Max Load Fan location

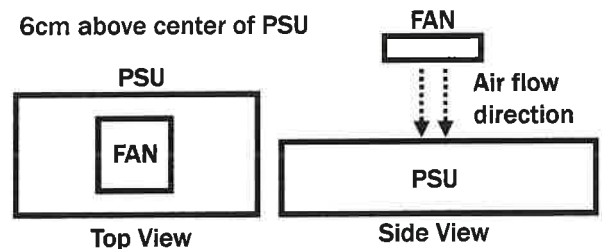

5.2 Storage temperature

-40°C to 85°C

5.3 Operating humidity

5% to 95% RH, non-condensing

5.4 Altitude

0 to 5000m

5.5 MTBF

> 160Khrs (based on MIL-HDBK-217F, rated load, 50°C)

6.0 INTERNATIONAL STANDARDS

6.1 Safety standards

Label Voltage : 100Vac to 240Vac

UL 60950-1

CSA 22.2 NO.60950-1

EN 62368-1

6.2 EMI standards

FCC docket 20780 curve "B"

CISPR 22 "B"

EN 61000-3-2 class "D"

EN 61000-3-3

6.3 EMS standards

| | | |
|--------------|---|-------------|
| EN61000-4-2 | 8kV/contact discharge, 15kV/air discharge | Criterion A |
| EN61000-4-3 | 10V/M with 80% AM | Criterion A |
| EN61000-4-4 | 2kV (100KHz) | Criterion A |
| EN61000-4-5 | 1kV/Line-Line, 2kV/Line-Earth | Criterion A |
| EN61000-4-6 | 10V with 80% AM | Criterion A |
| EN61000-4-8 | 30A/m | Criterion A |
| EN61000-4-11 | 30% dips 500ms, | Criterion A |
| | 60% dips 200ms, | Criterion B |
| | 100% dips 10ms, | Criterion A |
| | 100% dips 5000ms, | Criterion B |
| | 100% dips 20ms, | Criterion B |

7.0 MECHANICAL SPECIFICATION

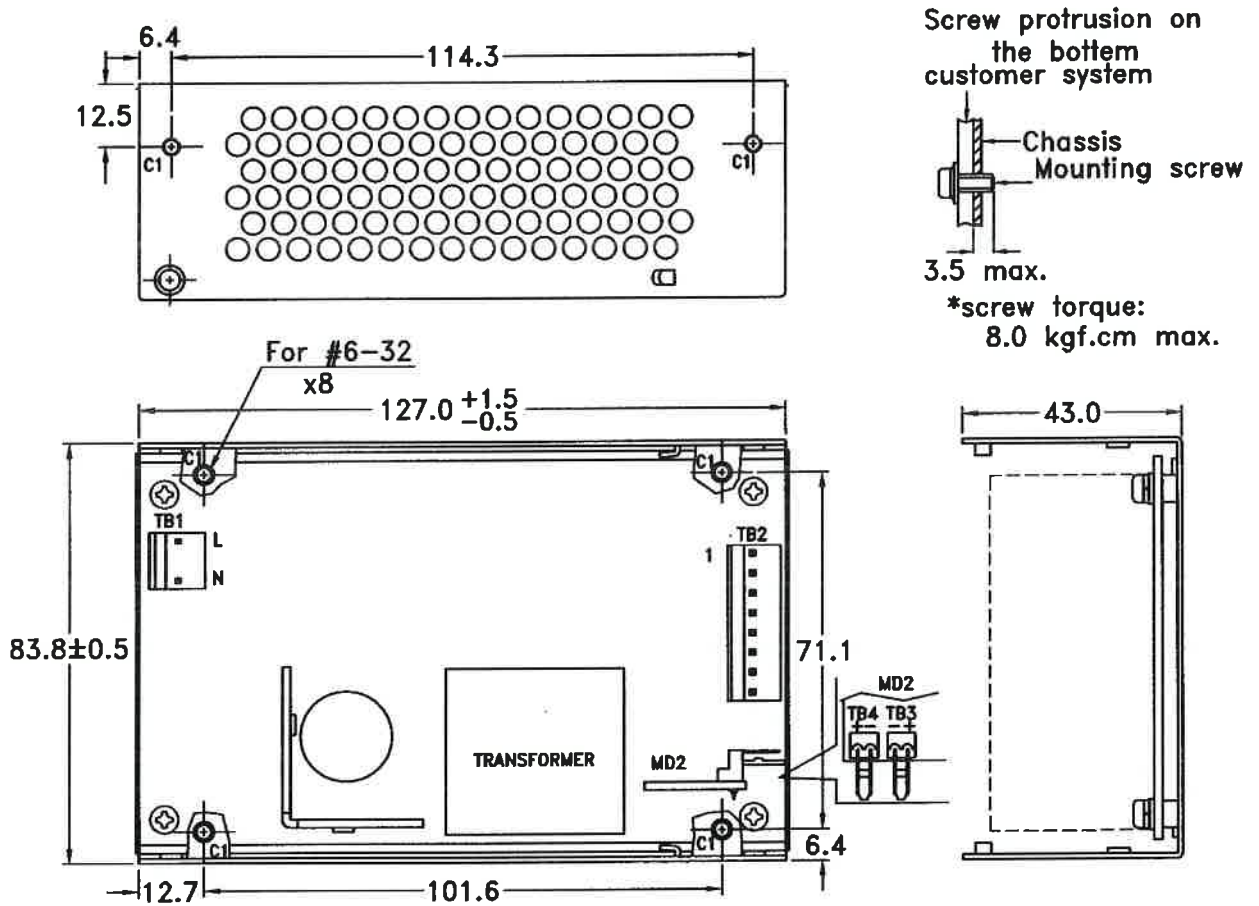

7.1 Dimensions

Dimensions shown in mm as above. Tolerance is specified ± 0.4 mm dimension.

7.2 Connectors

- TB1-- AC Input : Molex 5277-02A or equivalent , mating with Molex 5239-03 or equivalent
- TB2-- DC Output : Molex 5273-08A or equivalent , mating with Molex 5239-08 or equivalent
- TB3-- For +12V Fan use only : Molex 5046-02A or equivalent , mating with Molex 5051-02 or equivalent
- TB4-- For Remote Sense : Molex 5046-02A or equivalent , mating with Molex 5051-02 or equivalent

7.3 DC Output pin assignment

- Pin 1 +V 5 GND
- 2 +V 6 GND
- 3 +V 7 GND
- 4 +V 8 GND

7.4 Packing

- Net weight : 520 g approx. / unit
- Carton size(mm) : 384 (L) x 339 (W) x 327(H)
- Quantity : 24 units / carton
- Gross weight : 14.6 kg approx. / carton

8.0 PERFORMANCE (input voltage is 115VAC, unless others specified)

8.1 Switching frequency ripple

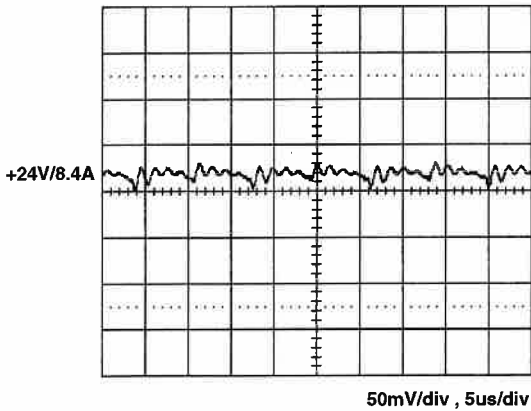

8.2 Line frequency ripple

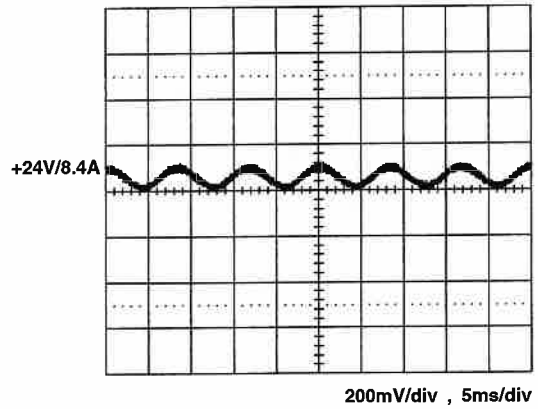

8.3 Output turn on wave form

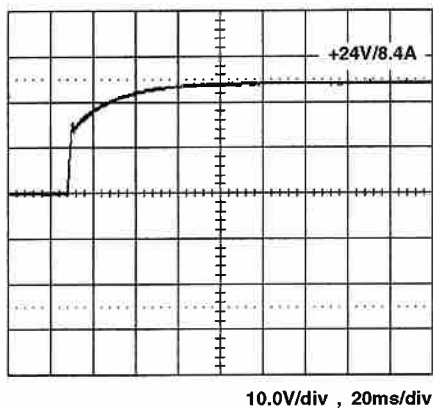

8.4 Output turn off wave form

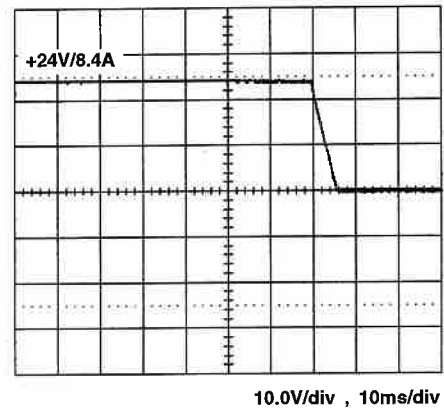

8.5 Hold-up time

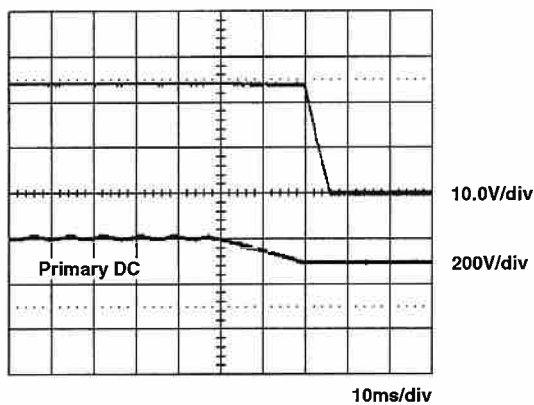

8.6 Over voltage protection

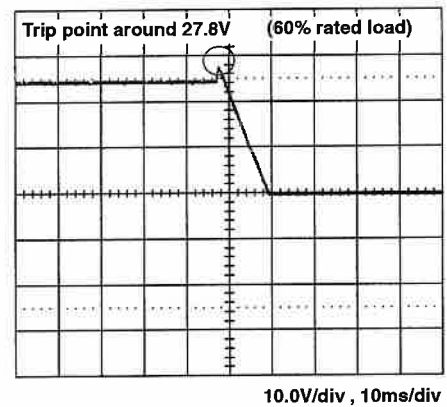

8.7 +24V Step response

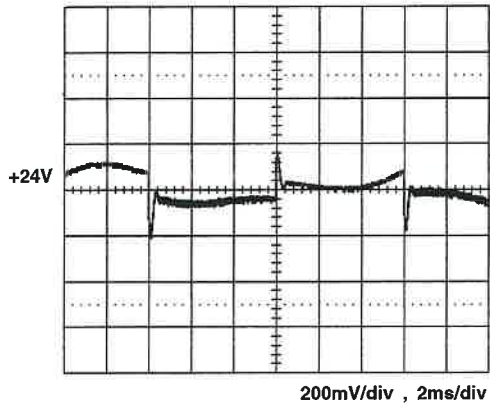

+24V step from 1.68A to 8.4A

8.8 Peak Load

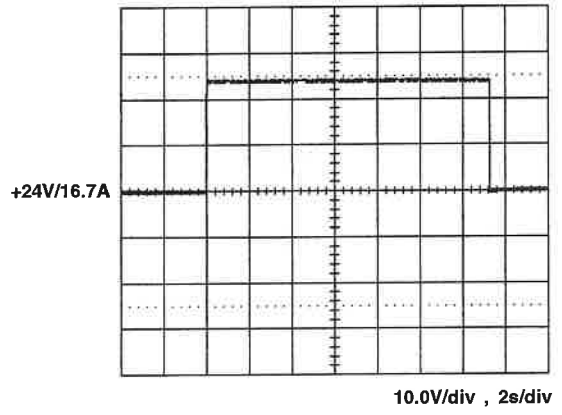

8.9 FCC B performance

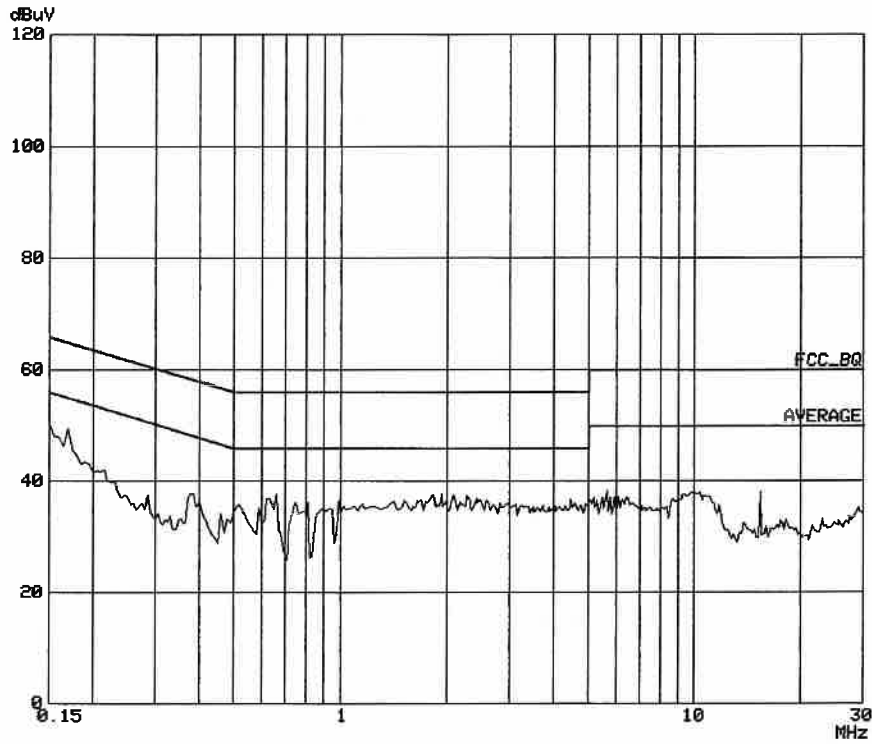

8.10 EN55022 "B"

