



SPECIFICATION

For

SWITCHING POWER SUPPLY

M/N : SNP-G207-UM

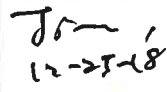
STANDARD PRODUCT

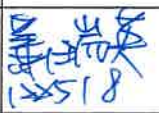
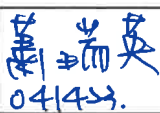
Reviewed by Product Manager	 12-25-18	 4-19-18				
Typed by Document Assistant	 12-25-18	 041433				
SKYNET ELECTRONIC			LAST REV. NO.			

1.0 INTRODUCTIONS

SNP-G207-UM is a 3"×5" open frame, general purpose, rated 200W SMPS. It also features in Medical safety and green power.

2.0 INPUT SPECIFICATIONS

2.1 Input Voltage

Input voltage range : 90Vac to 264Vac

Nominal line voltage : 115Vac/230Vac

2.2 Input frequency

47Hz to 63Hz

2.3 Input current

$4A_{\text{rms}}$ max/115Vac, $2A_{\text{rms}}$ max/230Vac

2.4 Inrush current

30A max/115Vac, 60A max/230Vac (EMI capacitors excluded, cold start at 25°C)

2.5 Test Condition

All specs except international standards or specs with special notes are defined and tested at nominal line input, rated load and 25°C.

3.0 OUTPUT SPECIFICATIONS

3.1 Load range

Vo	min. load	rated load	max. load	peak load
+12V	0A	16.5A	25A	33A

3.1.1 Factory adjustment

+11.9V to +12.1V (60% rated load, 115Vac)

3.1.2 Peak load max duration

5sec. (duty cycle <10%, average power <200W)

3.1.3 Min load for FAN use

To use fan output (TB3), Vo should have 20W min load.

3.2 Ripple and noise

< 120mV (20MHz bandwidth limited, 1X probe with 0.47uF parallel capacitor)

3.3 Line regulation

< ±0.5% (90Vac to 264Vac, compare with 115Vac)

3.4 Load regulation

< ±1% (20% to 100% rated load, compare with 60% rated load)

3.5 Capacitive load start-up capability

< 30000uF

4.0 GENERAL FEATURES

4.1 Efficiency

Rated load efficiency : 90% typical

Average efficiency of 25%, 50%, 75% and 100% rated load : >87%

4.2 Hold up time

20ms typical

4.3 No load input power

<0.5W (without FAN connection)

4.4 Protection

4.4.1 Over-voltage protection

Trip point : +13V to +16V (60% rated load)

Protection mode : Latch-off

4.4.2 Short circuit and over-load protection

Protection mode : Auto-recovery

4.5 Remote sense

Compensates 0.5V lead drop max.

5.0 ENVIRONMENT SPECIFICATIONS

5.1 Operating temperature

-20°C to 70°C

(For both rated and max load. output derates linearly to 50%load from 50°C to 70°C)

(Rated load with convection cooling; max load with 18 CFM forced air cooling)

Output derating graph

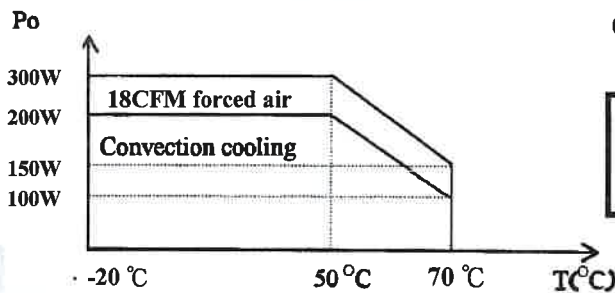

Max Load Fan location

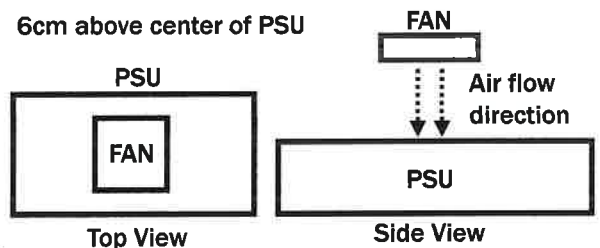

5.2 Storage temperature

-40°C to 85°C

5.3 Operating humidity

5% to 95% RH, non-condensing

5.4 Altitude

0 to 5000m

5.5 MTBF

> 160Khrs (based on MIL-HDBK-217F, rated load, 50°C)

6.0 INTERNATIONAL STANDARDS

6.1 Safety standards

Label Voltage : 100Vac to 240Vac

UL 60601-1

CSA 22.2 NO.60601-1

EN 60601-1

6.2 EMI standards

FCC docket 20780 curve "B"

CISPR 22 "B"

EN 61000-3-2 class "D"

EN 61000-3-3

6.3 EMS standards

EN61000-4-2	8kV/contact discharge, 15kV/air discharge	Criterion A
EN61000-4-3	10V/M with 80% AM	Criterion A
EN61000-4-4	2kV (100KHz)	Criterion A
EN61000-4-5	1kV/Line-Line, 2kV/Line-Earth	Criterion A
EN61000-4-6	10V with 80% AM	Criterion A
EN61000-4-8	30A/m	Criterion A
EN61000-4-11	30% dips 500ms,	Criterion A
	60% dips 200ms,	Criterion B
	100% dips 10ms,	Criterion A
	100% dips 5000ms,	Criterion B
	100% dips 20ms,	Criterion B

7.0 MECHANICAL SPECIFICATION

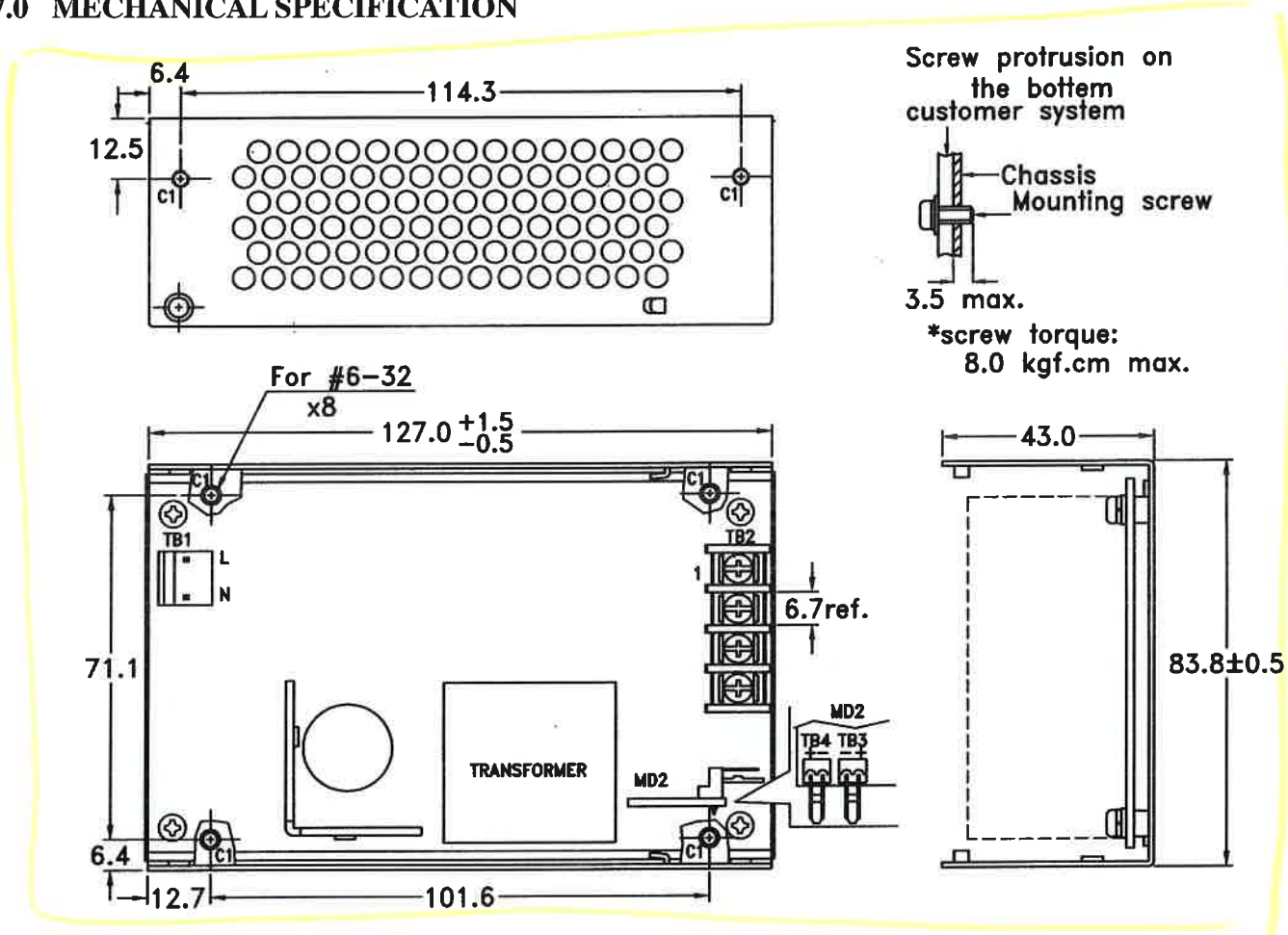

7.1 Dimensions

Dimensions shown in mm as above. Tolerance is specified ± 0.4 mm dimension.

7.2 Connectors

- TB1-- AC Input : Molex 5277-02A or equivalent , mating with Molex 52395-03 or equivalent
- TB2-- DC Output :Terminal blocks, pitch - 8.25mm
- TB3-- For +12V Fan use only : Molex 5046-02A or equivalent , mating with Molex 5051-02 or equivalent.
- TB4-- For Remote Sense : Molex 5046-02A or equivalent , mating with Molex 5051-02 or equivalent

7.3 DC pin assignment

Position	1 + V	2 + V	3 GND	4 GND
----------	-------	-------	-------	-------

7.4 Packing

- Net weight : 525 g approx. /unit
- Carton size(mm) : 384 (L) x 339 (W) x 327 (H)
- Quantity : 24 units / carton
- Gross weight : 15.0kg approx. / carton

8.0 PERFORMANCE (input voltage is 115VAC, unless others specified)

8.1 Switching frequency ripple

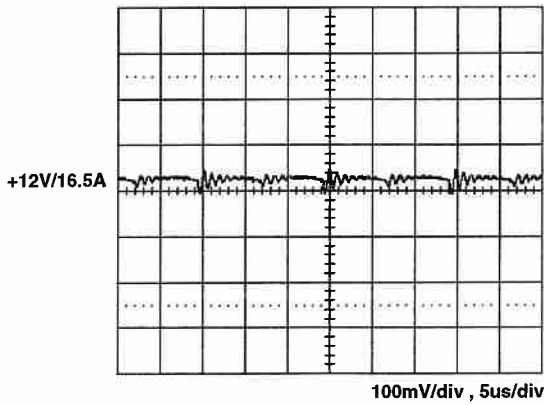

8.2 Line frequency ripple

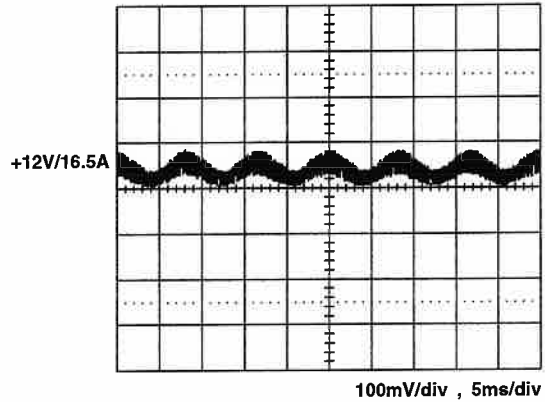

8.3 Output turn on wave form

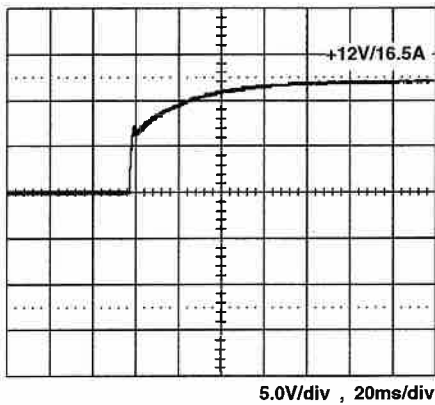

8.4 Output turn off wave form

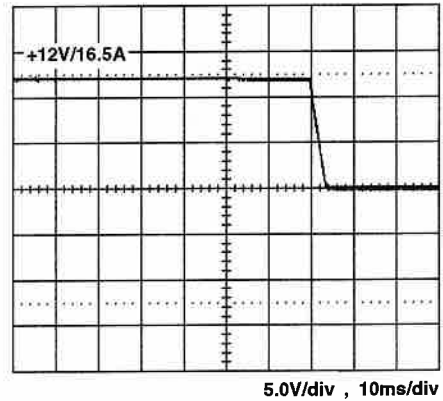

8.5 Hold-up time

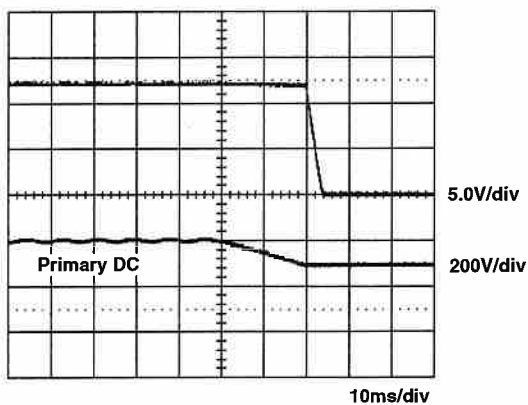

8.6 Over voltage protection

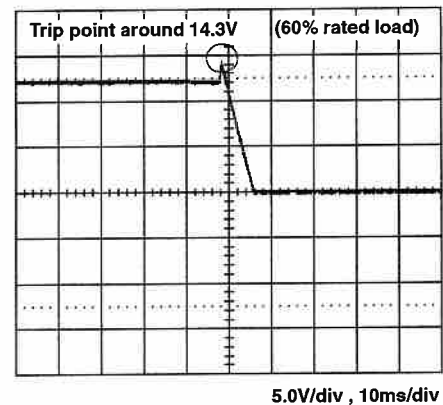

8.7 +12V Step response

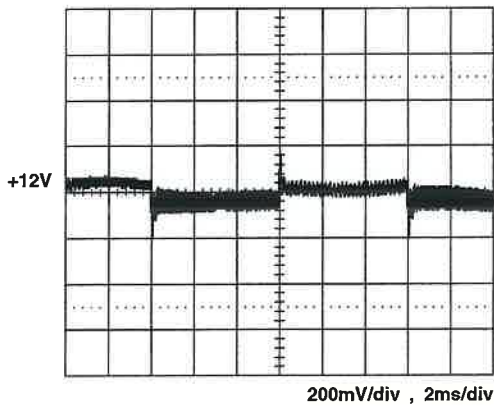

+12V step from 4.95A to 16.5A

8.8 Peak Load

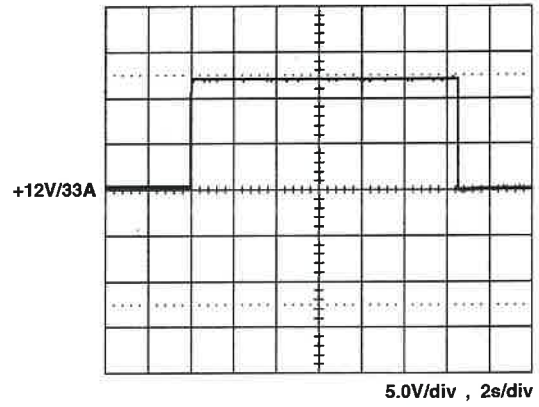

8.9 FCC B performance

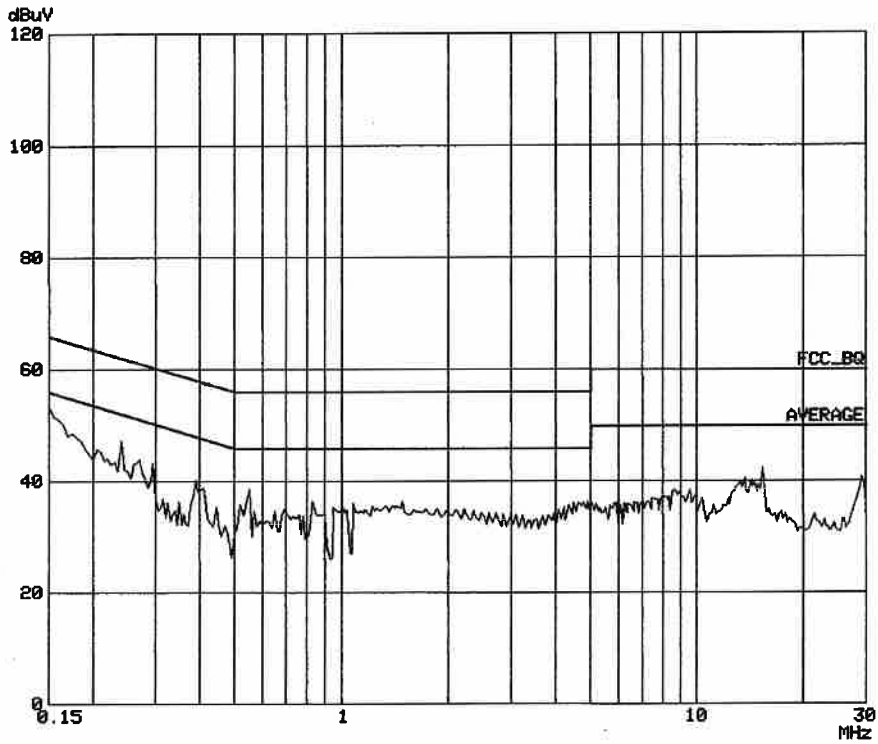

8.10 EN55022 "B"

