

SNP-G169-UM SPECIFICATION

**SPECIFICATION**

For

SWITCHING POWER SUPPLY

**M/N : SNP-G169-UM**

STANDARD PRODUCT

Reviewed by Product Engineer	Jim 6-14-16	Jim 12-25-18	Jim 9-14-23			
Typed by Document Assistant	蕭瑞英 061416	蕭瑞英 122418	蕭瑞英 041423			
<b>SKYNET ELECTRONIC</b>			<b>LAST REV. NO.</b>			

## 1.0 INTRODUCTIONS

SNP-G169-U is an open frame 24V/160W SMPS for general purpose use. It also features in Medical safety and green power.

## 2.0 INPUT SPECIFICATIONS

### 2.1 Input Voltage

Input voltage range : 90Vac to 264Vac

Nominal line voltage : 115Vac/230Vac

### 2.2 Input frequency

47Hz to 63Hz

### 2.3 Input current

$4A_{rms}$  max/115Vac,  $2A_{rms}$  max/230Vac

### 2.4 Inrush current

30A max/115Vac, 60A max/230Vac (EMI capacitors excluded, cold start at 25°C)

### 2.5 Test Condition

All specs except international standards or specs with special notes are defined and tested at nominal line input, rated load and 25°C.

## 3.0 OUTPUT SPECIFICATIONS

### 3.1 Load range

Vo	min. load	rated load	max. load	peak load
+24V	0A	6.66A	10.0A	13.3A

#### 3.1.1 Factory adjustment

+23.9V to +24.1V (60% rated load, 115Vac)

#### 3.1.2 Peak load max duration

10sec typ. (duty cycle < 10%, average power < 160W)

#### 3.1.3 Min load for FAN use

To use fan output (TB3), Vo should have 20W min load.

### 3.2 Ripple and noise

< 120mV (20MHz bandwidth limited, 1X probe with 0.47uF parallel capacitor)

### 3.3 Line regulation

< ±0.5% (90Vac to 264Vac, comparing with 115Vac)

### 3.4 Load regulation

< ±1% (20% to 100% rated load, comparing with 60% rated load)

### 3.5 Capacitive load start-up capability

< 7000uF

**4.0 GENERAL FEATURES**

**4.1 Efficiency**

Rated load efficiency : 90% typical

Average efficiency of 25%, 50%, 75% and 100% rated load : >87%

**4.2 Hold up time**

25ms typical

**4.3 No load input power**

<0.5W (without FAN connection)

**4.4 Protection**

**4.4.1 Over-voltage protection**

Trip point : +26V to +30V (60% rated load)

Protection mode : Latch-off

**4.4.2 Short circuit and over-load protection**

Protection mode : Auto-recovery

**5.0 ENVIRONMENT SPECIFICATIONS**

**5.1 Operating temperature**

-20°C to 70°C

(For both rated and max load. output load derates linearly to 50% from 50°C to 70°C)

(Rated load with convection cooling; max load with 18 CFM forced air cooling)

Output derating curve

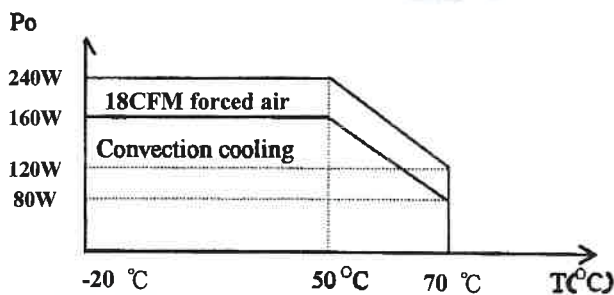

Max load fan location

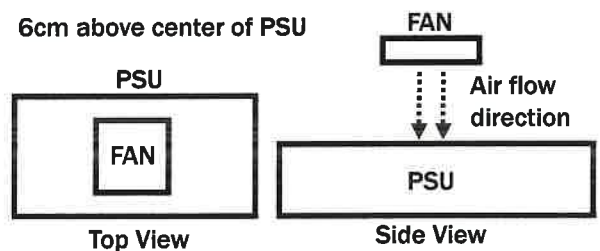

**5.2 Storage temperature**

-40°C to 85°C

**5.3 Operating humidity**

5% to 95% RH, non-condensing

**5.4 Altitude**

0 to 5000m

**5.5 MTBF**

> 180Khrs (based on MIL-HDBK-217F, rated load, 50°C)

**6.0 INTERNATIONAL STANDARDS**

**6.1 Safety standards**

Label Voltage : 100Vac to 240Vac

UL 60601-1

CSA 22.2 NO.60601-1

EN 60601-1

**6.2 EMI standards**

FCC docket 20780 curve "B"

CISPR 22 "B"

EN 61000-3-2 class "D"

EN 61000-3-3

**6.3 EMS standards**

EN61000-4-2	8kV/contact discharge, 15kV/air discharge	Criterion A
EN61000-4-3	10V/M with 80% AM	Criterion A
EN61000-4-4	2kV (100KHz)	Criterion A
EN61000-4-5	1kV/Line-Line, 2kV/Line-Earth	Criterion A
EN61000-4-6	10V with 80% AM	Criterion A
EN61000-4-8	30A/m	Criterion A
EN61000-4-11	100% dips 10ms,	Criterion A
	100% dips 20ms,	Criterion B
	30% dips 500ms,	Criterion A
	60% dips 200ms,	Criterion B
	100% dips 5000ms,	Criterion B

7.0 MECHANICAL SPECIFICATION

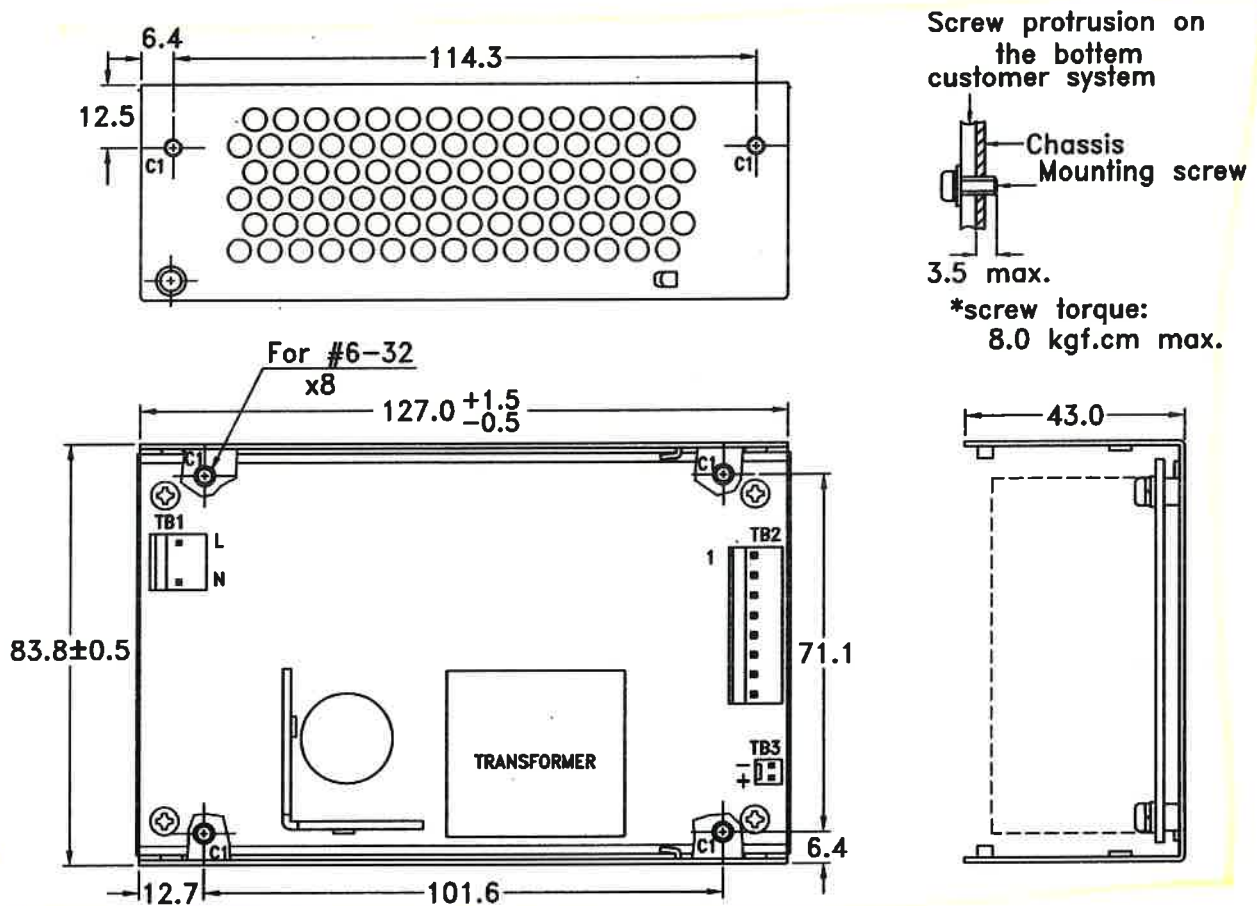

7.1 Dimensions

Dimensions shown in mm as above. Tolerance is specified +0.4mm dimension.

7.2 Connectors

- TB1-- AC Input : Molex 5277-02A or equivalent , mating with Molex 5239-03 or equivalent
- TB2-- DC Output : Molex 5273-08A or equivalent , mating with Molex 5239-08 or equivalent
- TB3-- For +12V Fan use only: Molex 5045-02A or equivalent , mating with Molex 5051-02 or equivalent

7.3 DC Output pin assignment

Pin 1 +V	5 GND
2 +V	6 GND
3 +V	7 GND
4 +V	8 GND

7.4 Packing

- Net weight : 505 g approx. / unit
- Carton size(mm) : 384 (L) x 339 (W) x 327(H)
- Quantity : 24 units / carton
- Gross weight : 14.3 kg approx. / carton

**8.0 PERFORMANCE** (input voltage is 115VAC, unless others specified)

**8.1 Switching frequency ripple**

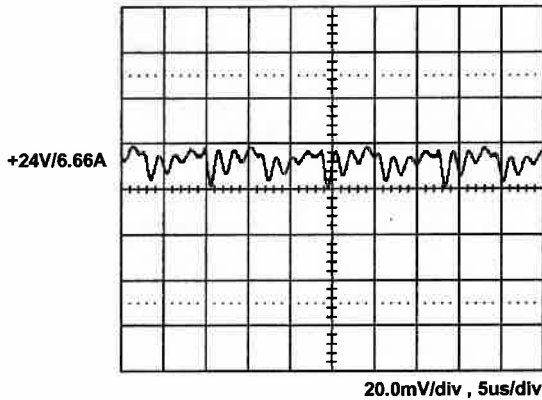

**8.2 Line frequency ripple**

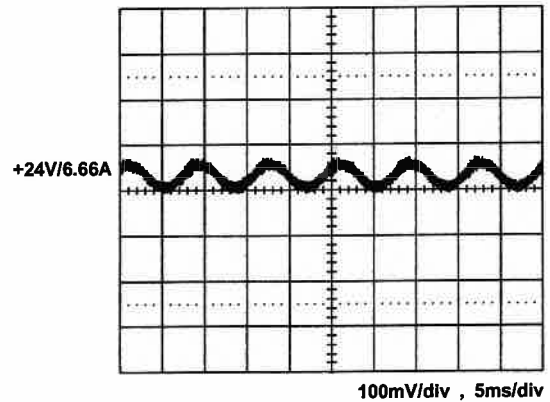

**8.3 Output turn on wave form**

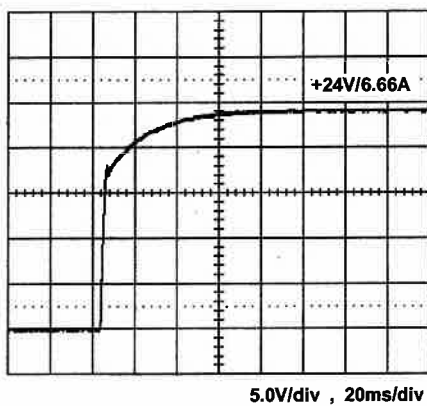

**8.4 Output turn off wave form**

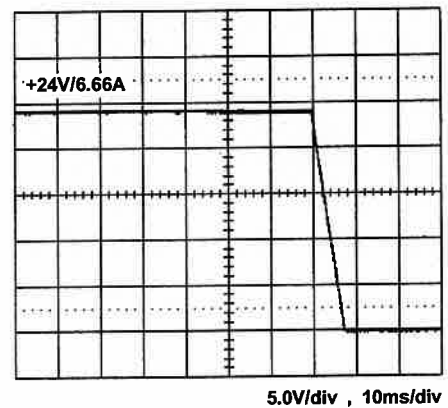

**8.5 Hold-up time**

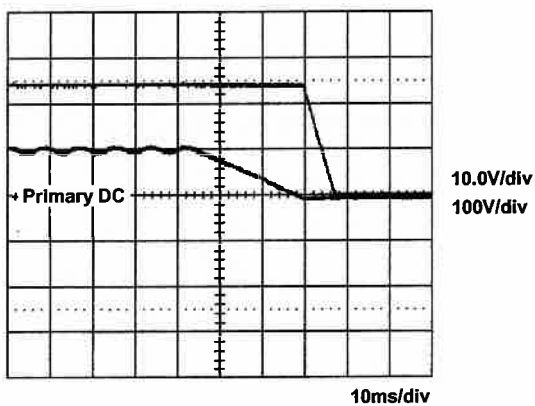

**8.6 Over voltage protection**

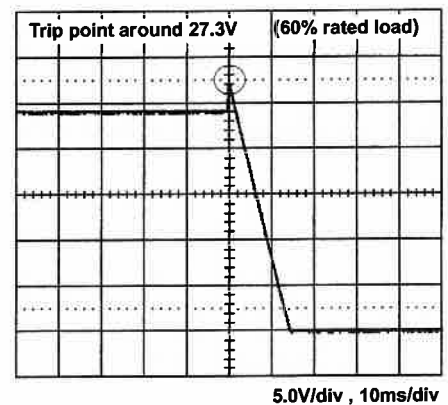

8.7 +24V Step response

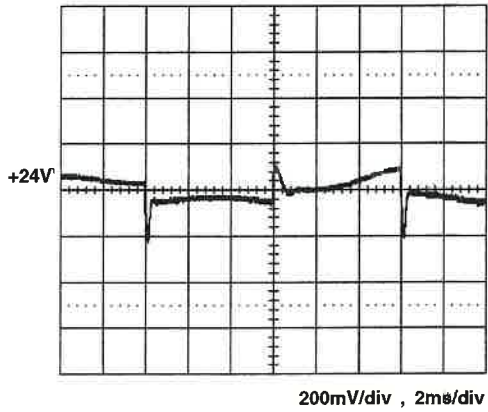

+24V step from 1.998A to 6.66A

8.8 Peak Load

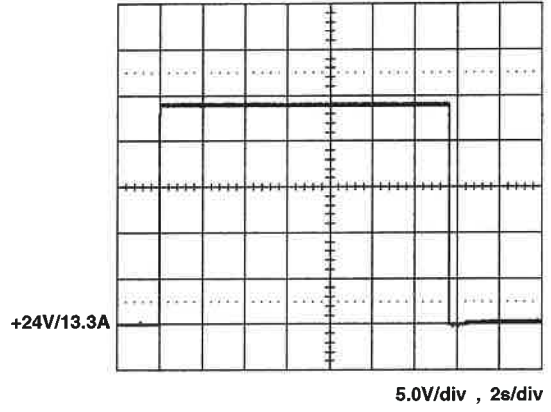

### 8.9 FCC B performance

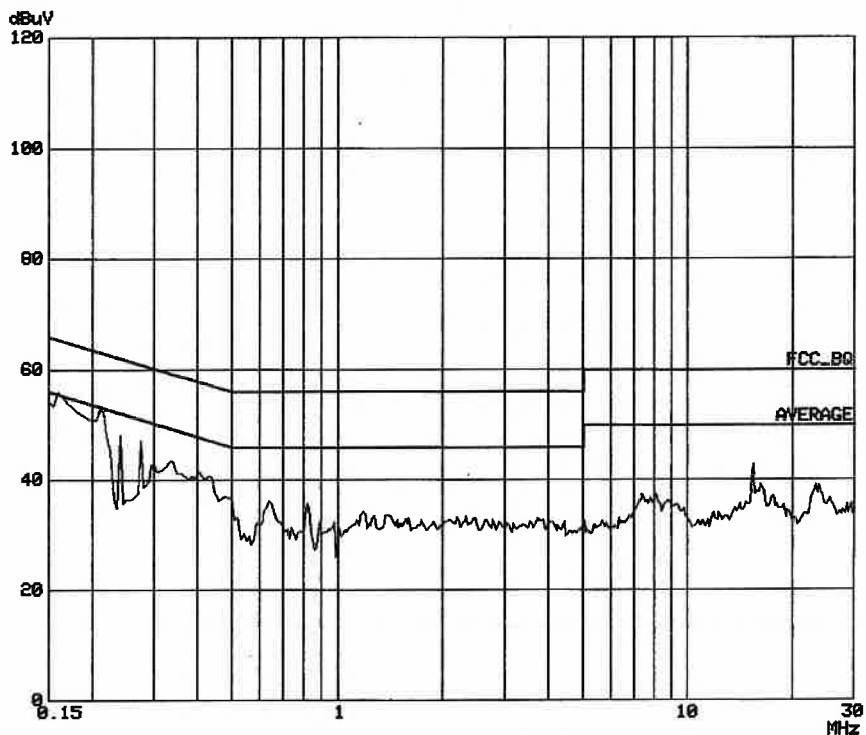

### 8.10 EN55022 "B"

