



2" x 4.2" x 1.4"

General Specifications:

Input voltage 90 VAC to 264 VAC
 Input frequency 47 Hz to 63 Hz
 Inrush current < 30/60A at 115/230VAC
 Hold up time 20ms typical
 Over load/Short circuit protection auto recovery
 Over voltage protection latch off
 Operating temperature -20°C to 70°C
 derating: 2.5% / °C > 45°C for convection cooling
 Storage temperature -40°C to +85°C

Features:

- Peak load (1.4 ~ 2 x rated current, Vo=rated for 5 sec)
- Design for BF application
- Convection cooling for Rated power
- Built-in PFC and 12V output for fan, available for G12x, G16x, and G20x
- EMI class B
- -20°C to +70°C operating temperature

Applications:

- For peak load and surge load applications, such as motor drive, coffee machine, vending machine, gaming machine, and other industrials.
- For EMI class B application, such as home healthcare device, and other medical devices.

EMI EN55022 "B", EN61000-3-3
 Harmonics.....EN61000-3-2, class D
 EMS..... EN61000-4-2,-3,-4,-5,-6,-8,-11
 SafetyUL/CSA 60950-1, 2nd Ed., EN 62368-1, 2nd Ed.
 ANSI/AMMI/CSA/EN60601-1, 3.1 Ed.
 CB report, CE mark, RM report/file
 Energy Saving (for w/o -A suffix) ENERGY STAR
 for computers version 6.0
 for displays version 6.0
 ErP regulation EC(No) 1275/2008

Mechanical Specifications:

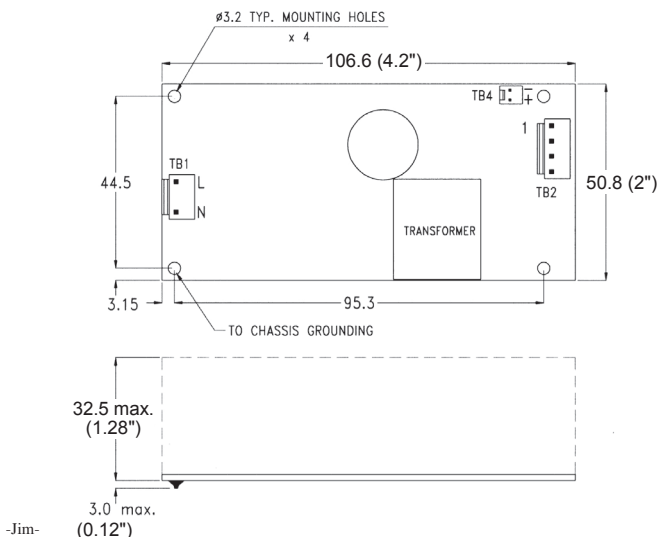

Notes:

1. Size:
2" x 4.2" x 1.4" / 50.8 x 106.6 x 35.5 (mm)
2. Mounting Hole:
44.5 x 95.3 (mm)
3. Connectors:
AC input: JST B2P3-VH or equivalent
DC output: JST B4P--VH
Fan: Molex 5045-02A or equivalent
4. Output Pin assignment:
Function Pin assignment:

1	2	3	4
GND	GND	Vo	Vo

	TB3
Function Pin	FAN Output
1	GND
2	+12V
5. Packing:
Net weight: 160 g approx. / unit
Gross weight: 10 kg approx. / carton, 80 units / carton
Carton size (mm): 422 (L) x 412 (W) x 287 (H)

10 years Warranty (contact Skynet's Distributors for details)

Output Specifications:

MODEL NO.	OUTPUT RAIL	LOAD				INITIAL ACCURACY	STEP EFFICIENCY			AVERAGE EFFICIENCY
		MIN.	RATED	MAX.	PEAK		@ 20% LOAD	@ 50% LOAD	@ 100% LOAD	
SNP-G127 SNP-G127 -A SNP-G127 -M SNP-G127 -MA SNP-G127 -H	+12V	0A	10.0A	12.5A	16.6A	+11.9V~+12.1V	82%	89%	90%	86.5%
SNP-G128 SNP-G128 -A SNP-G128 -M SNP-G128 -MA	+15V	0A	8.0A	10.0A	13.4A	+14.9V~+15.1V	82%	89%	90%	86.5%
SNP-G125 SNP-G125 -A SNP-G125 -M SNP-G125 -MA	+18V	0A	6.6A	8.3A	11.1A	+17.9V~+18.1V	82%	89%	90%	86.5%
SNP-G129 SNP-G129 -A SNP-G129 -M SNP-G129 -MA SNP-G129 -H	+24V	0A	5A	6.3A	8.3A	+23.8V~+24.2V	83.5%	90%	90.5%	88%
SNP-G12G SNP-G12G-A SNP-G12G-M SNP-G12G-MA	+28V	0A	4.3A	5.4A	7.2A	+27.9V~+28.1V	83.5%	90%	90.5%	88%
SNP-G12J SNP-G12J -A SNP-G12J -M SNP-G12J -MA	+36V	0A	3.4A	4.2A	5.6A	+35.8V~+36.2V	83.5%	90%	90.5%	88%
SNP-G12T SNP-G12T -A SNP-G12T -M SNP-G12T -M SNP-G12T -H	+48V	0A	2.5A	3.1A	4.2A	+47.8V~+48.2V	83.5%	90%	90.5%	88%

Note:

- Standby Power Consumption with System:**
For computers and displays, ENERGY STAR in U.S. and ErP regulation in Europe require the input power should be less than 0.5W at standby mode.
- Output Load:**
120W for convection cooling; 150W for forced air cooling.
- Peak Load Duration:**
Peak 200W can last for 5 sec.
- Isolation Grade:**
Primary ↔ Ground : 1MOPP (1500Vac)
Primary ↔ Secondary : 2MOPP (4000Vac)
Secondary ↔ Ground : 1MOPP (1500Vac)
- Leakage Current:**
Earth leakage current < 300uA
Touch current < 100uA
- EMI Grounding:**
If there is a metal sheet under the power supply, connect the EMI ground to the metal sheet.
- Model Selection:**
Most of power supplies will create audible burst sound at light load, if the application wants to meet input power < 0.5W at standby mode.
SNP-G12x is for ITE application which requires standby mode.
SNP-G12x-A is for ITE application but without burst sound and no standby mode.
SNP-G12x-M is for medical application which requires standby mode.
SNP-G12x-MA is for medical application but without burst sound and no standby mode.
SNP-G12x-H is for Home Healthcare application, input class II.

-Jim-

Performance for SNP-G127:

1. Switching frequency ripple

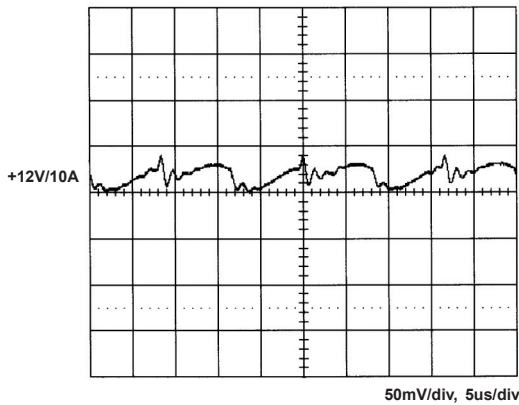

2. Line frequency ripple

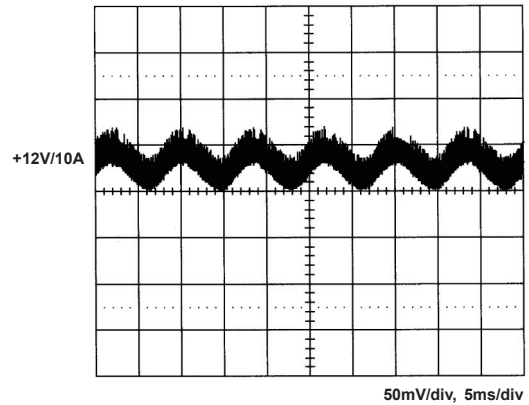

3. Output turn on wave form

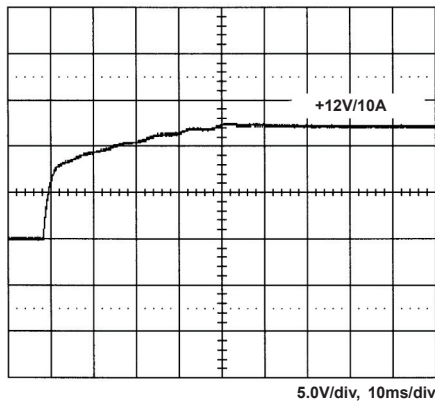

4. Output turn off wave form

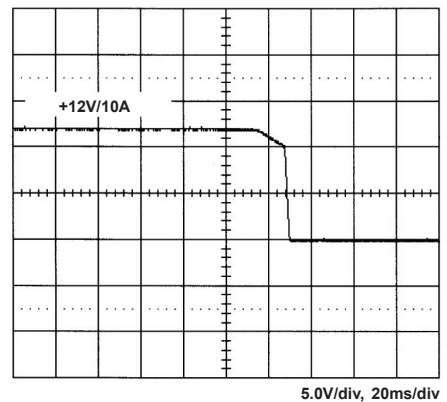

5. Hold-up time

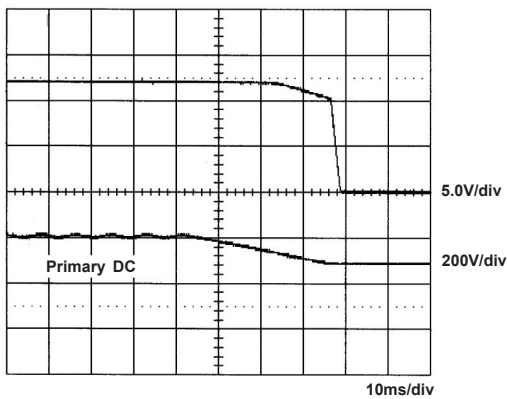

6. Over voltage protection

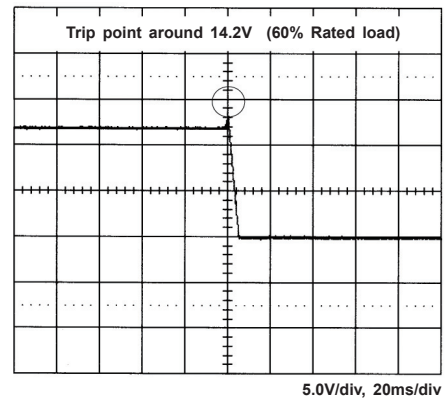

7. +12V step response

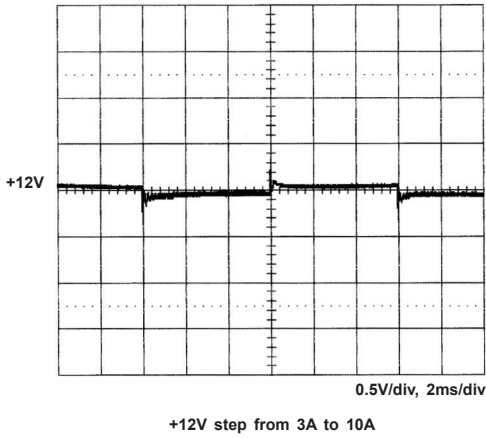

8. +12V peak load

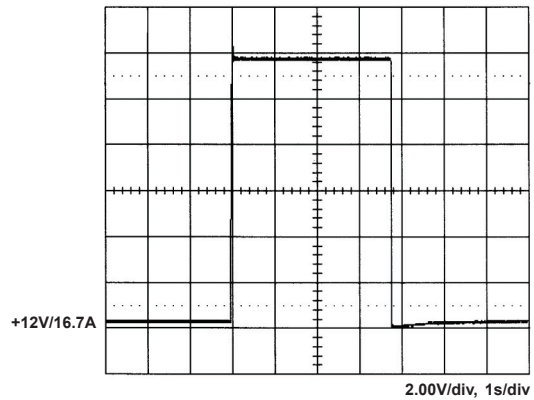

9. FCC B

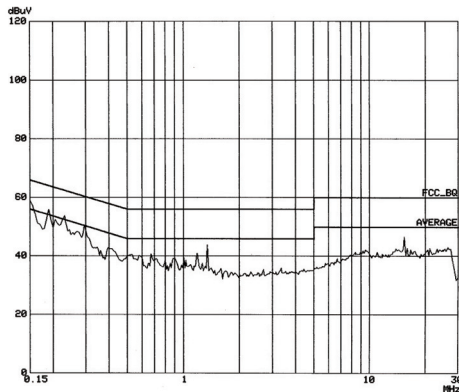

10. CISPR 22 B

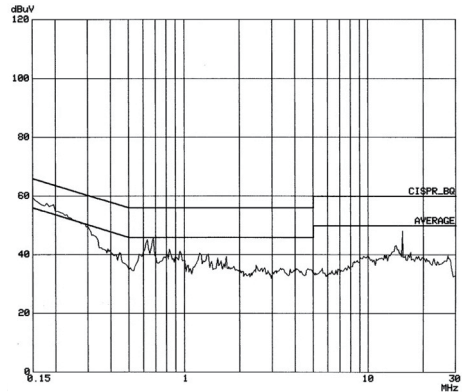

11. Power derating curve

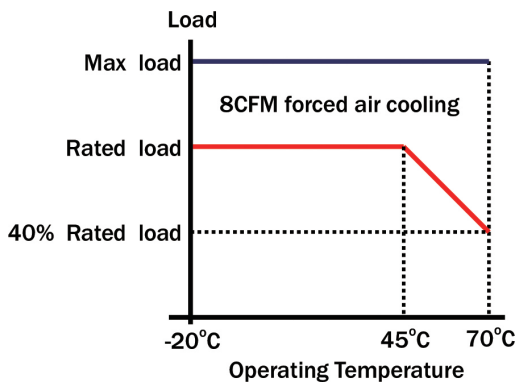

12. Capability for driving motor

