





# SPECIFICATION

For

SWITCHING POWER SUPPLY

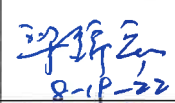
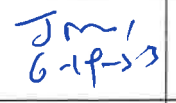
- SNP-M159-1
- SNP-M159-1U
- SNP-M159-1C

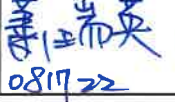
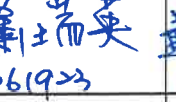
STANDARD PRODUCT

Reviewed by Product Engineer	 8-19-22	 6-19-23	 7-24-23			
Typed by Document Assistant	 0817-22	 0619-23	 07125-23			
<b>SKYNET ELECTRONIC</b>			LAST REV. NO.			

**1.0 INTRODUCTIONS**

The SNP-M159-1C is a four outputs open frame power supply.

The rated load is 150W with convection cooling. With forced air cooling the output power can reach up to 220W. Moreover, it can support 350W peak load for 5sec without shut down. It's good for ITE and Medical type BF application.

**2.0 INPUT SPECIFICATIONS**

**2.1 Input Voltage**

The range of input voltage is from 90VAC to 264VAC, Nominal line 115VAC/230VAC. Withstand 300Vac surge input for 5sec.

**2.2 Input Frequency**

The range of input frequency is 47Hz to 63Hz. The range of input nominal frequency is from 50Hz to 60Hz, It should not be damaged at 45Hz to 65Hz.

**2.3 Input Current**

The maximum input current is 4.0A at 115VAC or 2.0A at 230VAC.

**2.4 Inrush Current**

The inrush current will not exceed 30A at 115VAC input or 60A at 230VAC input cold start, 25°C. (EMI capacitors excluded)

**3.0 OUTPUT SPECIFICATIONS**

**3.1 Load range**

Output	min. load	rated load	max load	Peak Load	voltage accuracy
+5V	0.0A	4.5A	5.0A		+4.88V to +5.05V
+12V	0.0A	4.0A	4.5A		+11.75V to +12.12V
-12V	0.0A	1.25A	1.66A		-11.75V to -12.12V
+24V	0.0A	5A	5A	14.5A	+23.76V to +24.24V

At factory, the output in 60% rated load and nominal line condition, the +5V output is set to between 4.97V and 5.03V and +12V output is set to between 11.95V and 12.05V and +24V output is set to between 23.95V and 24.05V.

The +5Vdc output voltage shall be adjustable from 3Vdc to 5.5Vdc.

The +12Vdc output voltage shall be adjustable from 12Vdc to 18Vdc.

The -12Vdc output voltage shall be adjustable from -9Vdc to -13Vdc.

Total output power is 150W with convection cooling and 150W~220W with 10CFM forced air cooling.

The 24V rail is main output. It can supply 9A to 14.5A peak current for 5 seconds depend on how much load at the other outputs.

### 3.2 Ripple and noise

The peak to peak ripple and noise for all output is less than 1% of output voltage, at rated load and nominal line. Measuring is done by 20MHz bandwidth limited oscilloscope and terminated each output with a 0.47uF+10 uF capacitor.

### 3.3 Line regulation

The line regulation for all output are less than  $\pm 0.5\%$  while measuring at rated load and  $\pm 10\%$  of nominal line input voltage changing

### 3.4 Load regulation

The load regulation for all outputs are less than  $\pm 1\%$ , which are measured by changing the output load  $\pm 40\%$  from 60% rated load, and the other outputs are kept at 60% rated load and nominal line input.

### 3.5 start up time

The start up time is less than 1sec typ. at 100Vac, 50Hz input voltage, rated load and discharged capacitive load.

### 3.6 Capacitance loading capability

The 24V output can handle capacitive load at start-up up to 80000uF.

## 4.0 GENERAL FEATURES

### 4.1 Efficiency

The efficiency is  $\geq 87\%$  while measuring at nominal line and rated load.

### 4.2 Hold up time

The hold up time is 20 ms at 100VAC input and rated load, which is measured form the end of the last charging pulse to when the main output drops down to 95% output voltage.

### 4.3 Protection

#### 4.3.1 Over voltage protection

The built-in crowbar circuit will shut down the outputs to avoid damaging the external circuits. The trip point of over voltage protection at 24V output is around +27V to +31V. To recover from over voltage protection, cycle the AC line OFF and ON is necessary.

#### 4.3.2 Short circuit and over load protection

The power supply will generate a Auto Recovery mode to protect itself against Short circuit or over load conditions of +24V.

The +12V 、 -12V and +5V output has it's own circuit protection.

#### 4.3.3 Over Temperature protection

When the over temperature occurs the power supply will shut down and enter the auto recovery mode.

**5.0 ENVIRONMENT SPECIFICATIONS**

**5.1 Operating temperature**

-30°C to 70 °C, -30 °C to 50 °C no derating, above 50 °C, derate at 2.5% per degree from 50 °C to 70 °C. (start up at -30 °C/ and the range of the input voltage is from 100Vac to 264Vac).

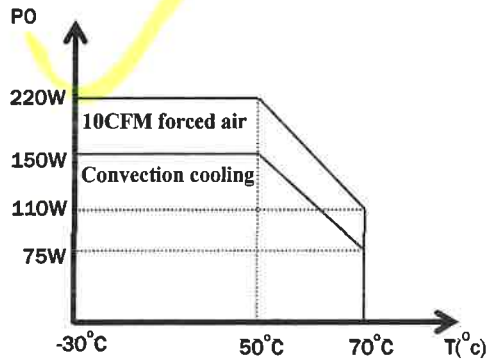

MAX Load Fan location

6cm above center of PSU

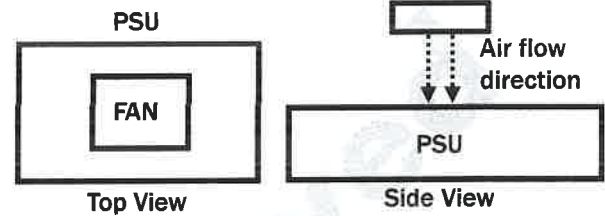

**5.2 Storage temperature**

-40°C to +85°C

**5.3 Operating humidity**

10% to 85% Non-Condensing

**5.4 Storage humidity**

10% to 95% Non-Condensing.

**5.5 Altitude**

Will operate properly at any altitude between 0 to 5000m.

**5.6 MTBF**

>200Khrs (based on SR-332, rated load, 50 °C )

**6.0 INTERNATIONAL STANDARDS**

**6.1 Safety standards** (Label voltage: 100Vac to 240Vac)

Designed to meet the following regulations :

UL/CSA/EN/IEC 62368-1

ANSI/AMMI/CSA/EN/IEC 60601-1,3.1 edition

**6.2 EMI standards**

Designed to meet the following limits :

FCC level "B"

EN55032, level "B"

EN55011, level "B"

EN61000-3-2 class "D"

EN 61000-3-3

**6.3 EMS standards**

Designed to meet the following limits :

IEC60601-1-2:2014

IEC61000-4-2	level 1	level 2	level 3	level 4	
Vertical non-direct contact	+2KV	+4KV	+6KV	+8KV	Criterion A
Horizontal non-direct contact	+2KV	+4KV	+6KV	+8KV	Criterion A
Contact discharge	+2KV	+4KV	+6KV	+8KV	Criterion A
Air discharge	+2KV	+4KV	+8KV	+15KV	Criterion A
IEC61000-4-3 : 2006 +A1	10V/M with 80M --2.5GHz				Criterion A
IEC61000-4-4 : 2012	Line to Line +-2KV ; Line to ground +-2KV.				Criterion A
IEC61000-4-5 : 2014	Line to Line 0.5,1.0KV;Line to ground 0.5,1.0,2.0KV.				Criterion A
IEC61000-4-6 : 2013	10V with 0.15MHz --80MHz				Criterion A
IEC61000-4-8 : 2009	30 A/M test at 50,60Hz				Criterion A
IEC61000-4-11 : 2004	Test at 100VAC, 50Hz +-2%, 100% rated load				
	Phase degree	interval time	test cycle		
100 % dips 10 ms	*	10 sec	3		Criterion A
60 % dips 200 ms,	*	10 sec	3		Criterion B
30 % dips 500 ms,	0°	10 sec	3		Criterion A
100% dips 5000ms	0°,180°	7 sec	3		Criterion B
100% dips 20ms	0°	10 sec	3		Criterion B

\* : 0,45,90,135,180,225,270,315 degree.

**6.4 Others**

Comply with ROHS

7.0 MECHANICAL SPECIFICATION

7.1 Dimensions

Dimensions shown in mm [inch] as below. Tolerance specified is + -0.4mm[0.016].

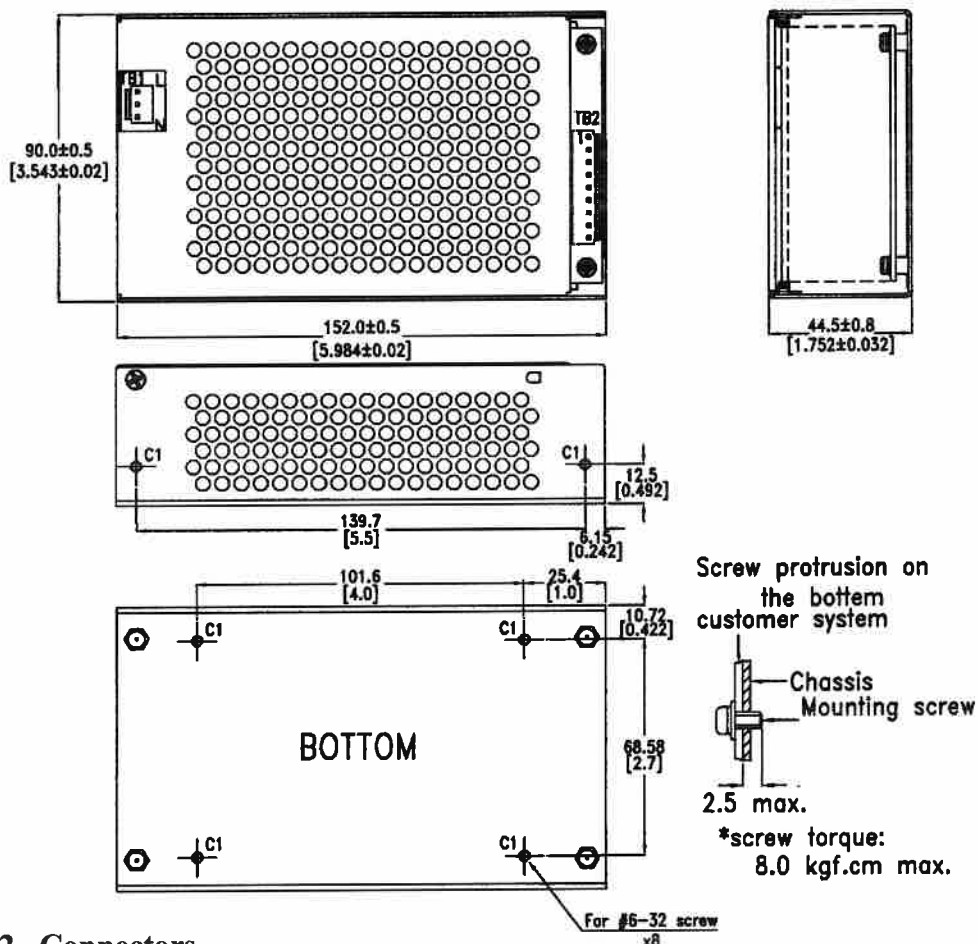

7.2 Connectors

TB1--AC Input : JST B2P3-VH or equivalent.  
(Mates with : JST VHR-3N Housing or equivalent.)

TB2--DC Output : JST B9P-VH or equivalent.  
(Mates with : JST VHR-9N Housing or equivalent.)

7.3 DC Output pin assignment

PIN 1	-12V	4	+5V	7	GND
2	+12V	5	GND	8	+24V
3	+5V	6	GND	9	+24V

7.4 Packing

- Net weight : 626 g approx. / unit
- Carton size(mm) : 413 (L) x 377 (W) x 267 (H)
- Quantity : 20 units / carton
- Gross weight : 15.0 kg approx. / carton

8.0 APPLICATION NOTE

8.1 For Class I connection

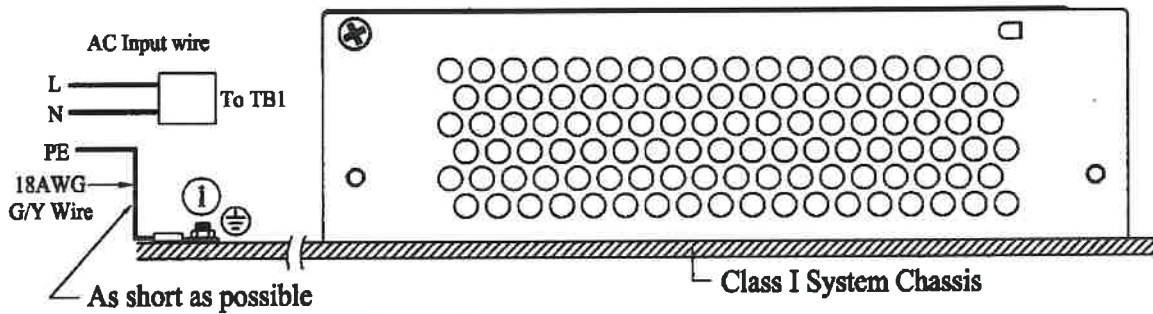
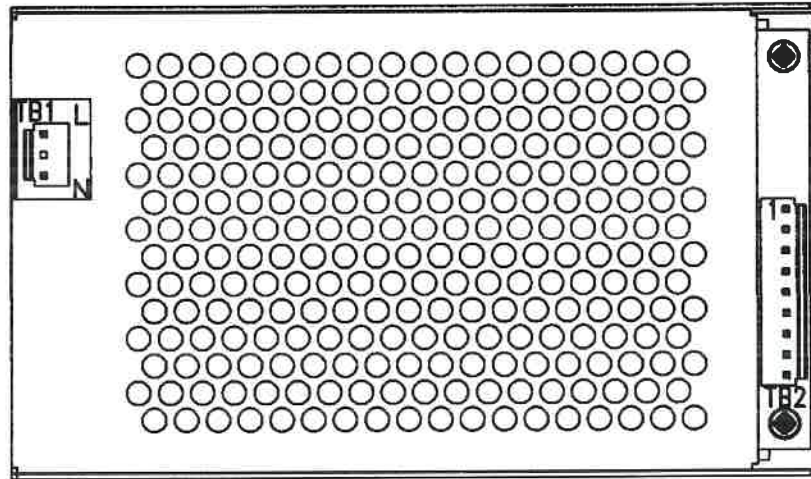

Note:

Must be fixed properly after the ground wire go into chassis for safety reason.



**8.0 PERFORMANCE (input voltage is 100VAC, unless others specified)**

**8.1 Switching frequency ripple**

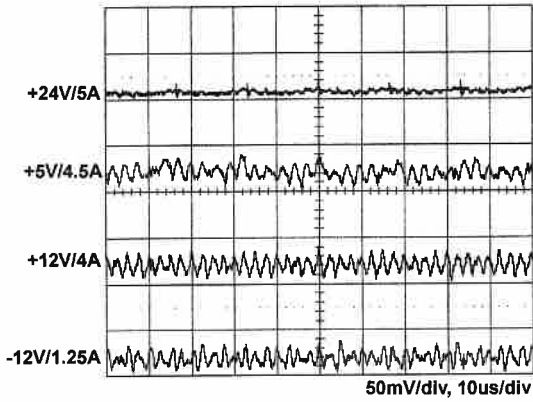

**8.2 Line frequency ripple**

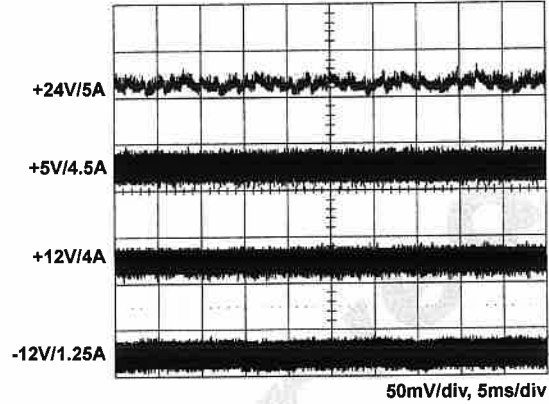

**8.3 Output turn on wave form**

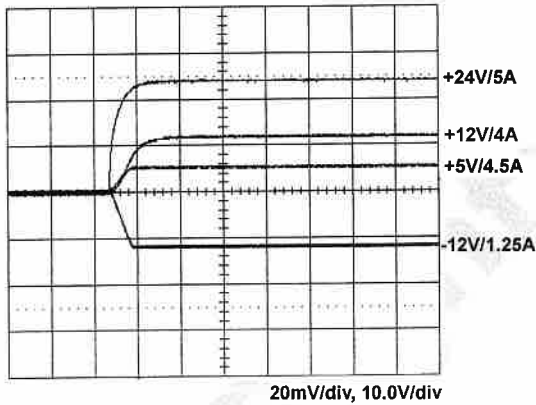

**8.4 Output turn off wave form**

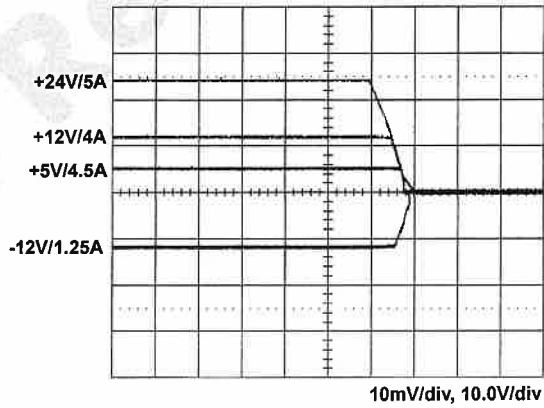

**8.5 Hold-up time**

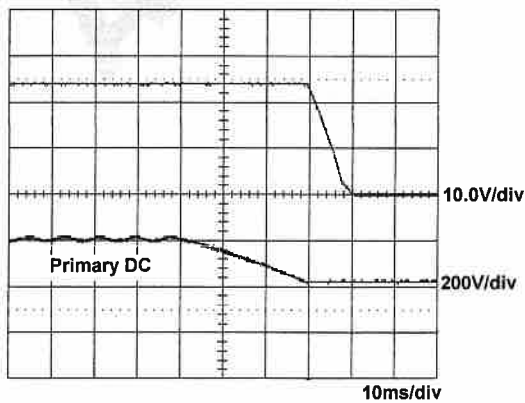

**8.6 +24V over voltage protection**

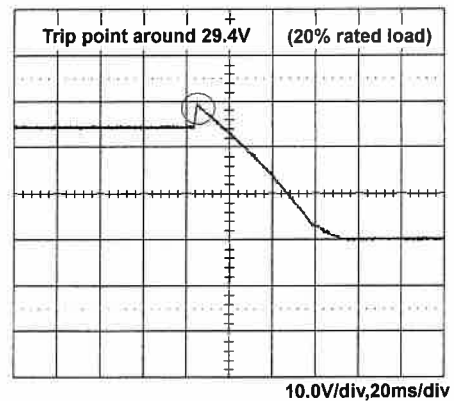



8.7 +24V step response

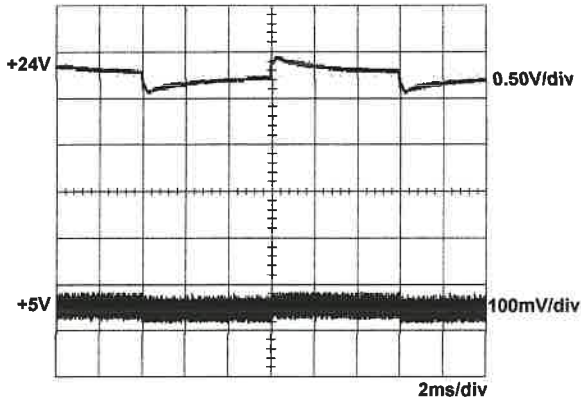

+24V step from 1A to 5A  
other output at 60% load

8.8 +5V step response

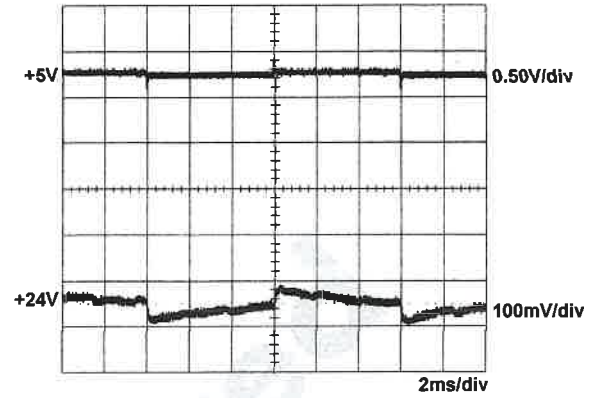

+5V step from 0.9A to 4.5A  
other output at 60% load

8.9 Start up time

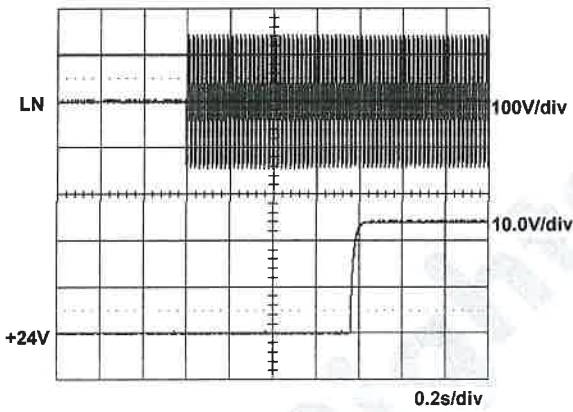

8.10 peak load

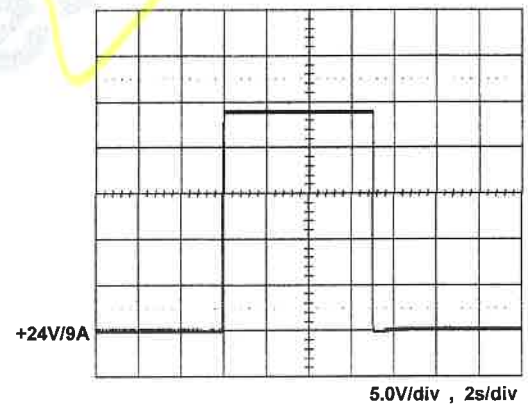

### 8.11 FCC "B" QP performance

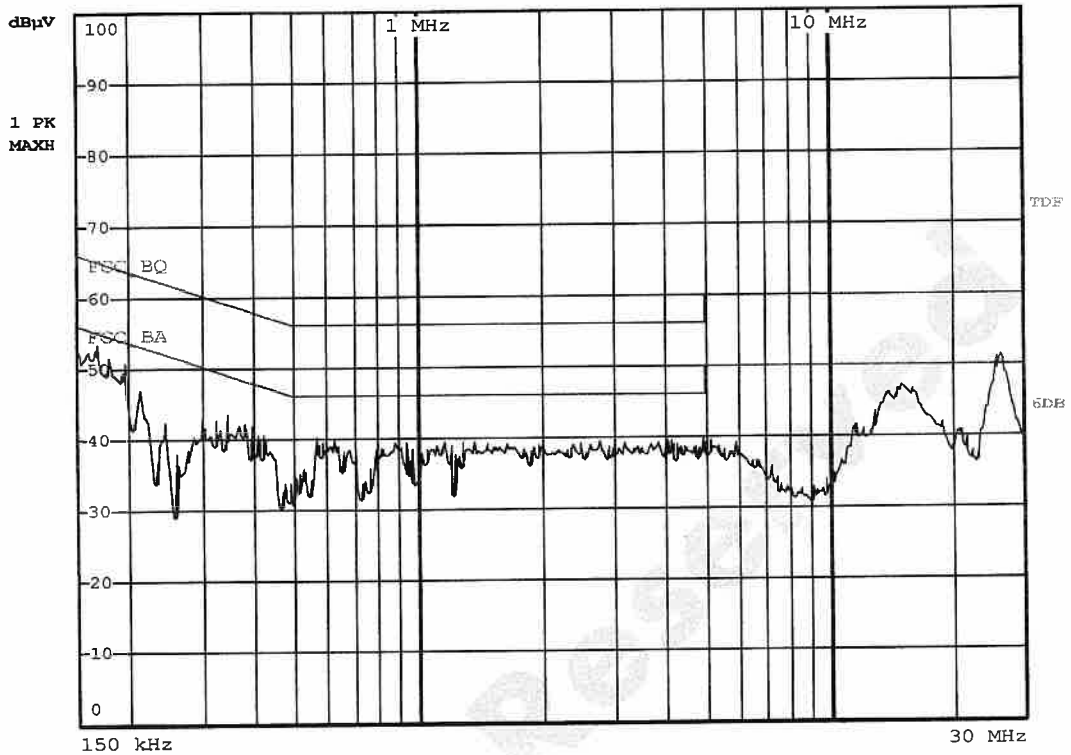

### 8.12 CISPR "B" QP performance

