

SPECIFICATION

For

SWITCHING POWER SUPPLY

M/N : SNP-HF37-A

STANDARD PRODUCT

All Rights Reserved

Reviewed by Product Engineer	J.m 2-22-19	J.m 1-6-17	J.m 8-14-21			
Typed by Document Assistant	黃志英 022119	黃志英 010621	黃志英 281422			
SKYNET ELECTRONIC			LAST REV. NO.			

1.0 INTRODUCTIONS

SNP-HF37-A is a 30W rated output 12V/2.5A,45W peak load switching mode supply for medical & ITE application.

The feature on this model: design for BF application 、 high torque capability 、 up to 3,000uF loading start-up 、 low leakage current : Earth<300uA ; touch<100uA 、 flexible installation for Class I / II 、 1.57"×2.76" × 0.9 " compact size 、 5000m operating altitude 、 -40°C to 70°C convection cooling 、 eco-friendly design.

2.0 INPUT SPECIFICATIONS

2.1 Input voltage

Input voltage range : 90Vac to 264Vac

Nominal line voltage : 115Vac/230Vac

2.2 Input frequency

47Hz to 63Hz

2.3 Input current

2A_{rms} max/115Vac, 1A_{rms} max/230Vac

2.4 Inrush current

40A max/115Vac, 80A max/230Vac (EMI capacitors excluded, cold start at 25°C)

3.0 OUTPUT SPECIFICATIONS

All specs under item 3.0 except with special notes are defined and tested at nominal line input, rated load and 25°C

3.1 Load range

Vo	min. load	rated load	max load	peak load
+12V	0A	2.5A	3.33A	5A

3.1.1 Factory adjustment

+11.8 V to +12.2V (60% rated load, 115Vac)

3.1.2 Peak load max duration

2sec. (duty cycle < 50%, average power < rated power)

3.1.3 Cooling

Rated load for convection cooling ; max load for 18 CFM forced air cooling.

3.2 Ripple and noise

< 1% (20MHz bandwidth limited, 1X probe with 0.47uF parallel capacitor)

3.3 Line regulation

< ±0.5% (90Vac to 264Vac, compare with 115Vac)

3.4 Load regulation

< ±1% (20% to 100% rated load, compare with 60% rated load)

3.5 Capacitive load start-up

< 3,000uF

4.0 GENERAL FEATURES

All specs under item 4.0 except with special notes are defined and tested at nominal line input, rated load and 25°C

4.1 Average efficiency

>77% (Average from 20%, 50%, and 100% efficiency)

4.2 Step efficiency

- >62% at 10% rated load
- >72% at 20% rated load
- >80% at 50% rated load
- >82% at 100% rated load

4.3 Efficiency Curve

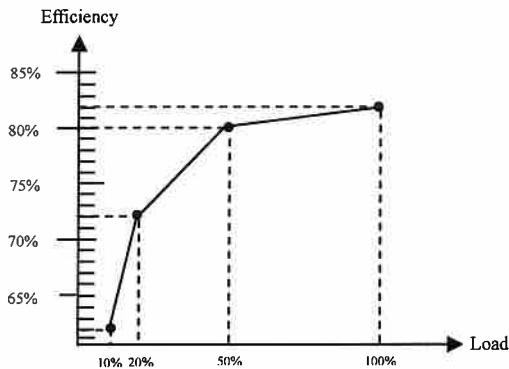

4.4 Hold up time

16 ms typical

4.5 No load input power

<1.5W

* For prevent audible noise , energy saving function is disabled.

4.6 Protection

4.6.1 Over-voltage protection

Trip point : +14V to +16.5V

Protection mode : Latch-off

4.6.2 Short circuit and over-load protection

Protection mode : Auto-recovery

5.0 ENVIRONMENT SPECIFICATIONS

5.1 Operating temperature

-40°C to 70°C

(For both rated and max load. output load derates linearly to 50% from 50°C to 70 °C)
 (Rated load with convection cooling; max load with 18 CFM forced air cooling)

Output derating curve

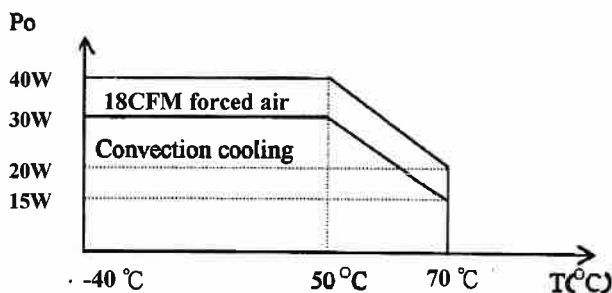

Max load fan location

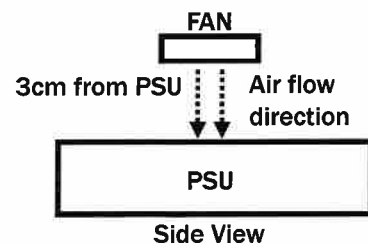

5.2 Storage temperature

-40°C to 85°C

5.3 Operating humidity

5% to 95% RH, non-condensing

5.4 Altitude

0 to 5000m

6.0 INTERNATIONAL STANDARDS**6.1 Safety standards**

Label voltage: 100Vac to 240Vac

UL/CSA 60950-1, 2nd editionEN 62368-1, 2nd editionANSI/AMMI/CSA/EN 60601-1, 3rd edition +A1**6.2 EMI standards**

FCC docket 20780 curve "B"

EN55022, level "B"

EN55011, level "B"

EN 61000-3-2 class "A"

EN 61000-3-3

6.3 EMS standards

EN61000-4-2	8kV/contact discharge, 15kV/air discharge	Criterion A
EN61000-4-3	10V/M with 80% AM	Criterion A
EN61000-4-4	2kV (100KHz)	Criterion A
EN61000-4-5	2kV/Line-Line, 4kV/Line-Earth	Criterion A
EN61000-4-6	10V with 80% AM	Criterion A
EN61000-4-8	30A/M	Criterion A
EN61000-4-11	100% dips 10ms,	Criterion A
	100% dips 20ms,	Criterion B
	30% dips 500ms,	Criterion A
	60% dips 200ms,	Criterion B
	100% dips 5000ms,	Criterion B

7.0 MECHANICAL SPECIFICATION

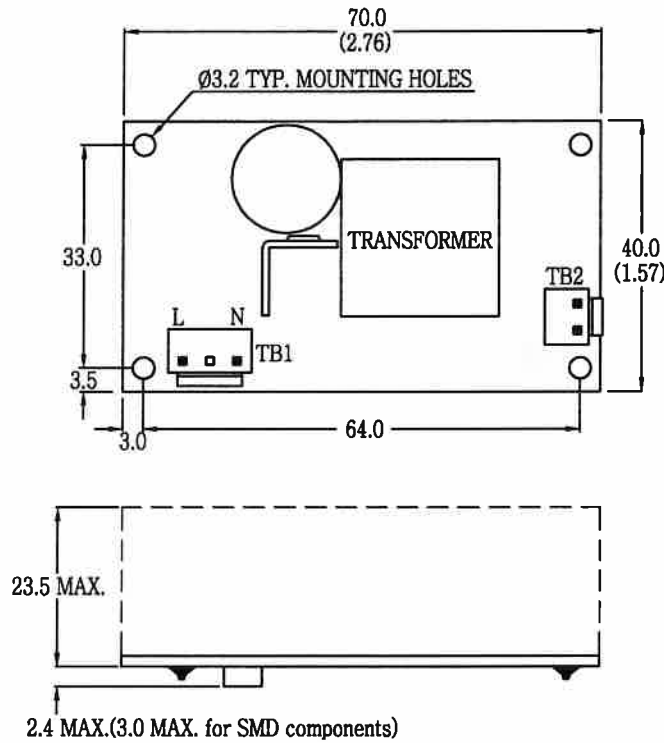

- Note :
1. It is suitable for Class I & Class II installation.
 2. The mount holes are only suitable for plastic spacer support, not for metal fasteners.

7.1 Dimensions

Dimensions shown in mm (inch) as above. Tolerance specified is $\pm 0.4\text{mm}$ (0.016 inch).

7.2 Connectors

TB1--AC Input : JST B2P3-VH or equivalent.

TB2--DC Output : JST B2P-VH or equivalent.

7.3 DC Output pin assignment

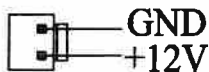

7.4 Packing

- Net weight : 61g approx. / unit
- Carton size(mm) : 412(L) x 327(W) x 283(H)
- Quantity : 150 units / carton
- Gross weight : 12.0kg approx. / carton

8.0 PERFORMANCE (input voltage is 115VAC, unless others specified)

8.1 Switching frequency ripple

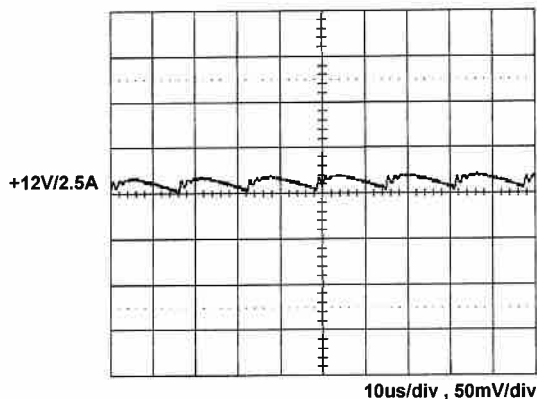

8.2 Line frequency ripple

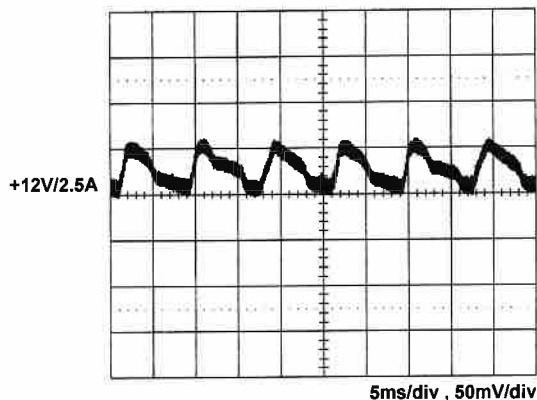

8.3 Output turn on wave form

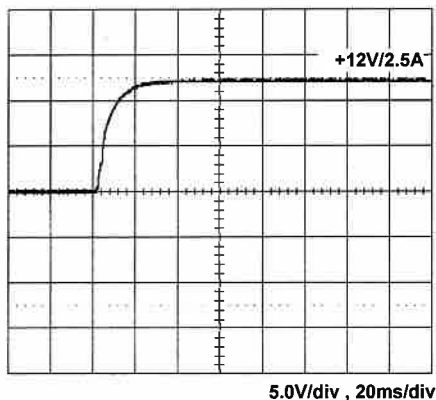

8.4 Output turn off wave form

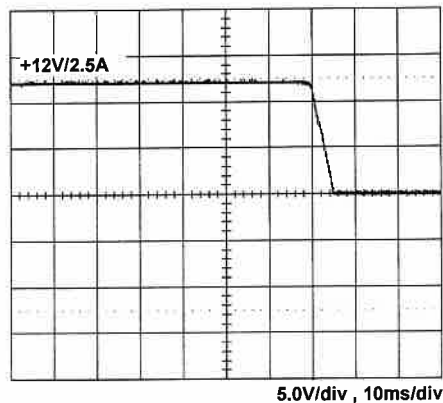

8.5 Hold-up time

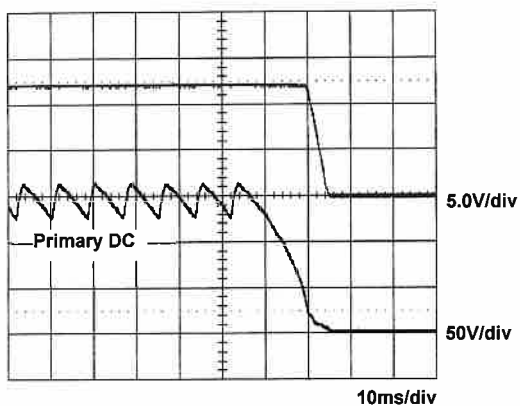

8.6 Over voltage protection

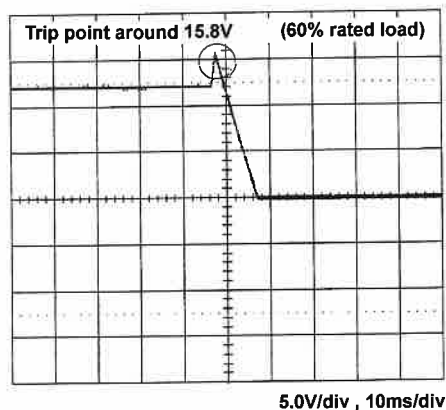

8.7 +12V Step response

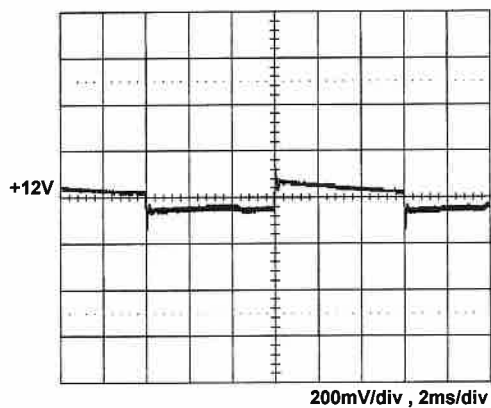

+12V step from 0.5A to 2.5A

8.8 FCC B performance class I

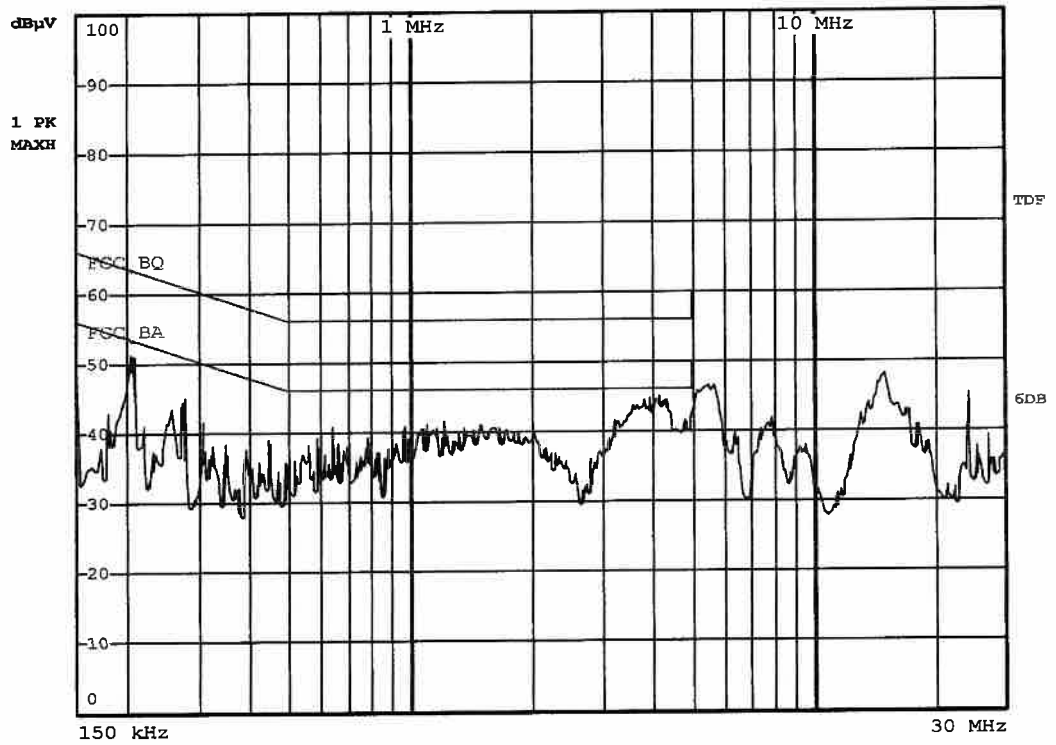

8.9 EN55011 22 "B" class I

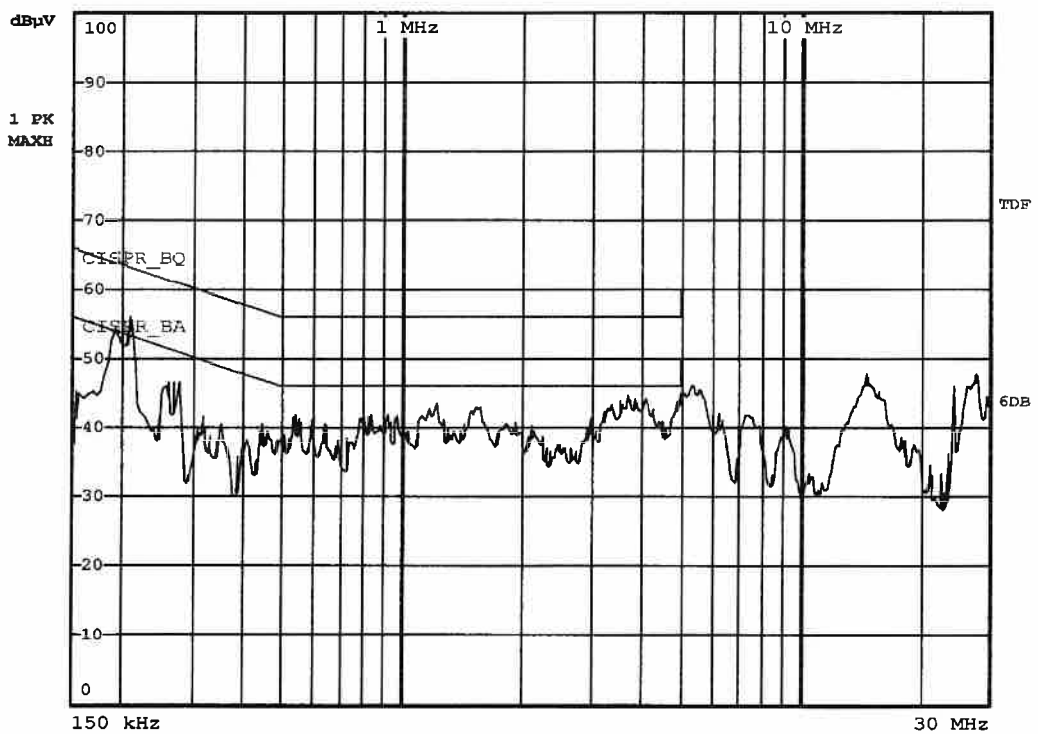

8.10 FCC B performance class II

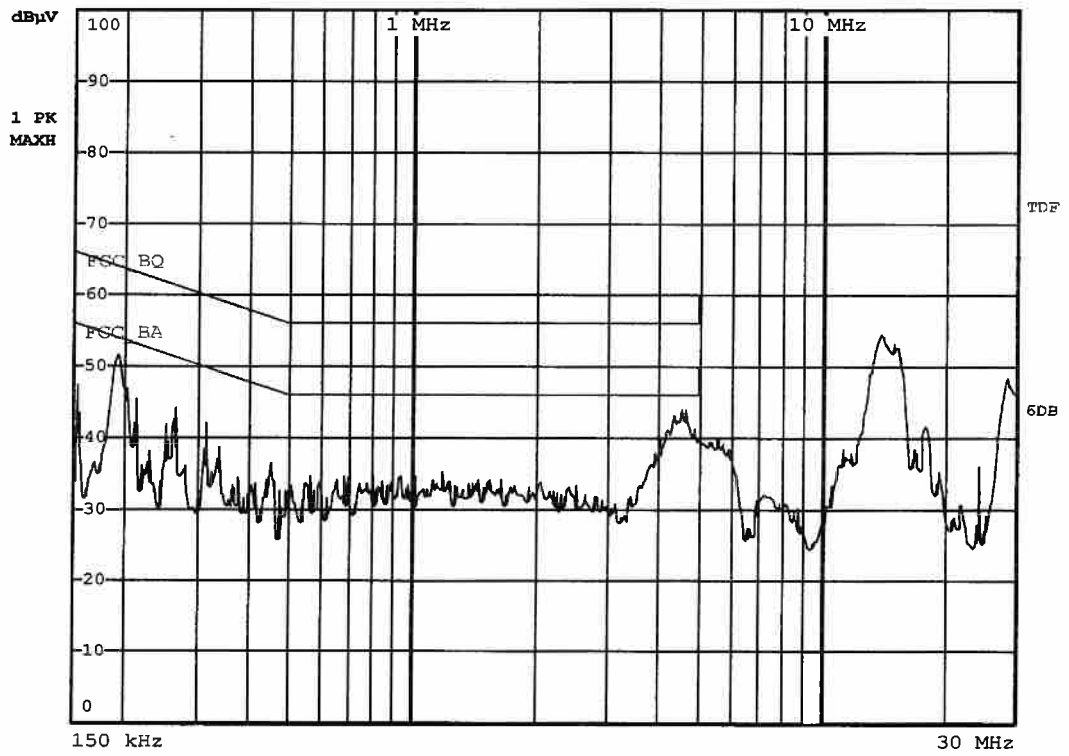

8.11 EN55011 22 "B" class II

