

SPECIFICATION

For

SWITCHING POWER SUPPLY

M/N : SNP-P309-S

STANDARD PRODUCT

All Rights Reserved

Reviewed by Product Engineer	Jm 8-12-23					
Typed by Document Assistant	黃芳儀 090727					
SKYNET ELECTRONIC		LAST REV. NO.				

1.0 INTRODUCTIONS

The SNP-P30X-S series provide 300Watt with convection cooling in a low profile(3.7”x 6.6”x1.46”). By forced air cooling, the max. output can reach to 420Watt and provide peak power to 600W within 5seconds. Even more built-in high torque current function is suitable for motor driver, loudspeaker or briefly high pulse current applications. More features as bellow: built-in +5V standby power & Remote on/off & Power good/fail signal &Variable Fan speed and Remote sense function.

The SNP-P309-S is certified to Medical and ITE safety whilst low leakage current for Type BF.

2.0 INPUT SPECIFICATIONS

2.1 Input voltage

The range of input voltage is from 90VAC to 264VAC. Nominal line 115VAC/230VAC.

2.2 Input frequency

The range of input frequency is from 47Hz to 63Hz.

2.3 Input current

The maximum input current is 5A at 115VAC or 2.5A at 230VAC.

2.4 Inrush current

The inrush current will not exceed 35A at 115VAC input or 70A at 230VAC input, cold start at 25°C. (EMI capacitors excluded)

2.5 Standby input power

Input power is less than 0.15W at no load (remote off)and115Vac/230Vac input.

Input power is less than 0.5W at 0.25W output(remote off) and115Vac/230Vac input.

Input power is less than 5W at No load (remote on)

3.0 OUTPUT SPECIFICATIONS

3.1 Load range

output	min. load	rated load	max. load	peak load	voltage range
+24V	0A	12.5A	17.5A	24A	21.6V to 26.4V
+5Vsb	0A	1 A	1.5A		4.25Vto 5.65V

3.1.1 Factory adjustment

At factory, the output in 60% rated load and nominal line condition, the +24V output is set to between 23.9V and 24.1V. The +5Vsb output is checked to be within the specified voltage accuracy range.

At peak load and nominal line, the output can last for 5sec without shut down.

3.1.2 Total output power

+24V/300W with convection cooling, 300W~420W with 10CFM forced air cooling.

+5Vsb/5W with convection cooling, 5W~7.5W with 10CFM forced air cooling.

3.2 Ripple and noise

The peak to peak ripple and noise for each output is less than 1%Vo at rated load and nominal line. Measuring is done by 15MHz band width limited oscilloscope and terminated output with a 0.47uF +47uF capacitor.

3.3 Line regulation

The line regulation for each output is less than + -1% while measuring at rated load and + -10% of nominal line input voltage changing .

3.4 Load regulation

The load regulation for each output is less than + -1% measuring are done by changing the measured output load + -40% from 60% rated load and nominal line

3.5 Capacitive load capability

The capacitance load start-up capability can be up to 20000uF at rated load and nominal line.

3.6 Remote sense

The +24V output has remote sense capability , compensation for 0.5V lead drop max.

3.7 High torque capability

The output current can provide 300% rated current for up to 1000ms, and output voltage can keep above 60% output voltage, but average current should not exceed rated current.

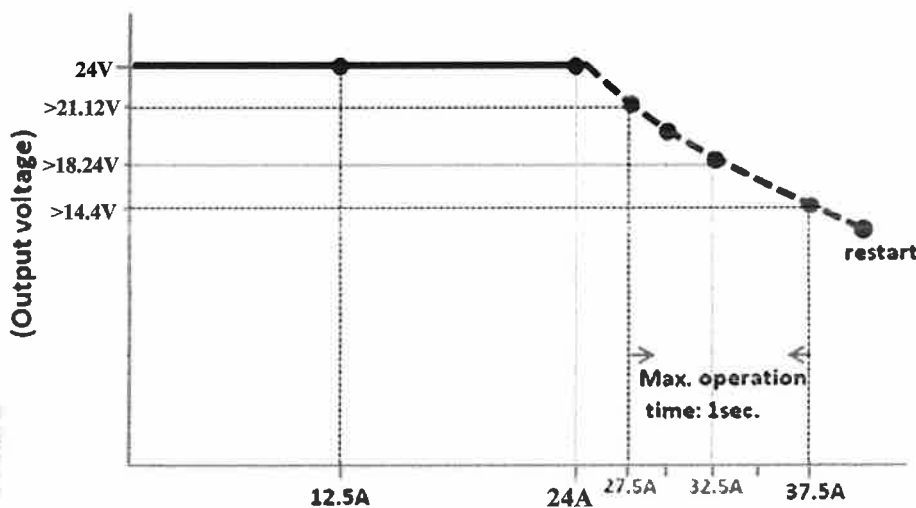

4.0 GENERAL FEATURES

4.1 Efficiency

The efficiency is typical 91% while measuring at nominal line and rated load.

4.2 Step efficiency

- > 77.5 % at 10% rated load
- > 86% at 20% rated Load
- > 90 % at 50% rated Load
- > 91% at 100% rated Load

4.3 Efficiency Curve

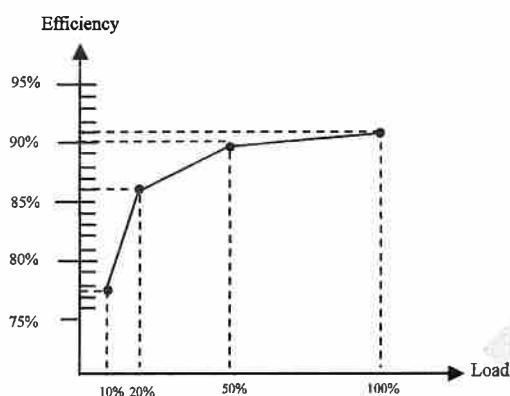

4.4 Hold up time

The hold up time is higher than 18ms at 115VAC input and rated load, which is measured from the end of the last charging pulse to when the main output drops down to 95% output voltage.

4.5 Protection

4.5.1 Over current protection

Trip point :110% to 130% Maximum load.

Protection mode : Auto-recovery.

4.5.2 Short protection

Protection mode : Auto-recovery

4.5.3 Over voltage protection

+24V trip point :+26.2V to 31V.

+5Vsb trip point :+7 V to +9.5V.

Protection mode : Latch-off.

4.5.4 The power supply has thermal protection

4.6 Remote on/off control

The TTL compatible signal(active low) is use to switch on the output. When remote pin is disconnected from secondary common, the output shall turn off

4.7 Fan speed control

The Fan output is only activated > 50% \pm 10% of rated load.

5.0 ENVIRONMENT SPECIFICATIONS

5.1 Operating temperature

-20°C to 70°C, -20°C to 50°C no derating, above 50°C, derate at 2.5% per degree from 50°C to 70°C.

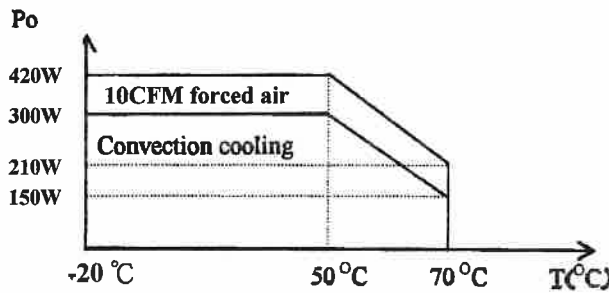

Max Load Fan location

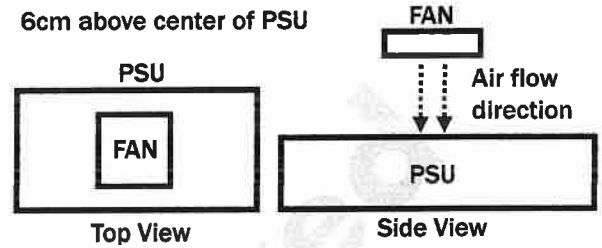

5.2 Storage temperature

-40°C to 85°C

5.3 Operating humidity

5% to 95% RH, non-condensing

5.4 Altitude

0 to 5000m

5.5 MTBF

>200Khrs(based on MIL-HDBK-217F, rated load, 50°C)

6.0 INTERNATIONAL STANDARDS

6.1 Safety standards (Label voltage: 100Vac to 240Vac)

- UL/CSA/ EN 60950-1
- UL/CSA/ EN 62368-1
- ANSI/AMMI/CSA/IEC/EN 60601-1

6.2 EMI standards

- FCC level "B"
- EN55022, level "B"
- EN55011, level "B"
- EN 61000-3-2 class "D" for loads > 110W

6.3 EMS standards

EN61000-4-2	8kV/contact discharge, 15kV/air discharge	Criterion A
EN61000-4-3	10V/M with 80% AM	Criterion A
EN61000-4-4	4kV	Criterion A
EN61000-4-5	1kV/Line-Line, 2kV/Line-Earth	Criterion A
EN61000-4-6	10V with 80% AM	Criterion A
EN61000-4-8	30A/m	Criterion A
EN61000-4-11	30% dips 500ms,	Criterion A
	60% dips 200ms,	Criterion B
	100% dips 10ms,	Criterion A
	100% dips 20ms,	Criterion B
	100% dips 5000ms,	Criterion B

7.0 MECHANICAL SPECIFICATION

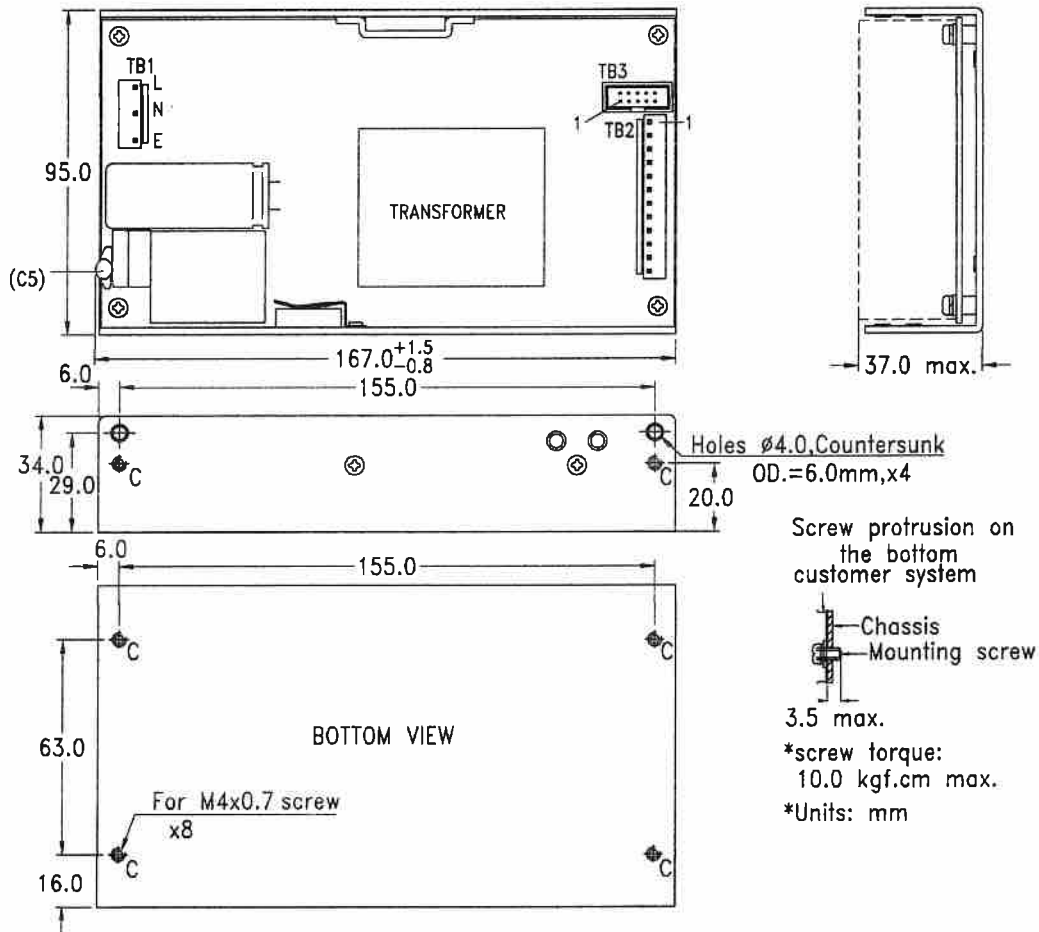

7.1 Dimensions

Size : 167mm(L) x95mm(W) x37mm(H),
Tolerance is +/-0.4mm between mounting holes, and +/-0.8mm for other dimension.

7.2 Connectors

- TB1-- AC input : using JST B5P-VH withdraw 2 pins or equivalent; mating with JST VHR-5N or equivalent.
- TB2-- DC Output : using JST B12P-VH or equivalent ; mating with JST VHR-12N or equivalent.
- TB3--SIGNALS : 2x5 (10 pins) 0.1 pitch.

7.3 TB2 pin assignment

Pin 1~6 +V 7~12 GND

7.4 TB3 pin assignment

	Pin 1. +5VSB	4. -FAN	7. RM GND	10. +RS
	2. +5VSB GND	5. NC	8. RM ON/OFF	
	3. +FAN	6. NC	9. -RS	

7.5 Packing

- Net weight : 660g approx. /unit
- Carton size(mm) : 453 (L) x 362 (W) x 279 (H)
- Quantity : 20 units / carton
- Gross weight : 15.4kg approx. / carton

8.0 PERFORMANCE (input voltage is 115VAC, unless others specified)

8.1 Switching frequency ripple

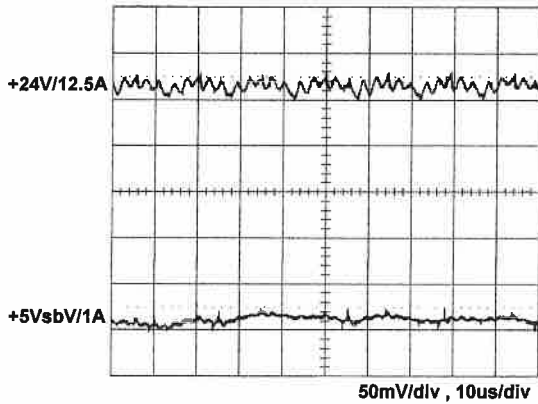

8.2 Line frequency ripple

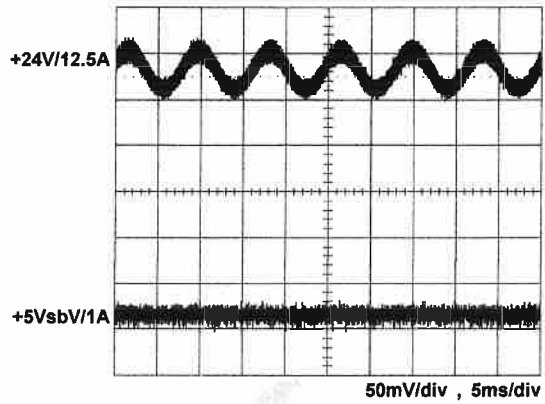

8.3 Output turn on wave form

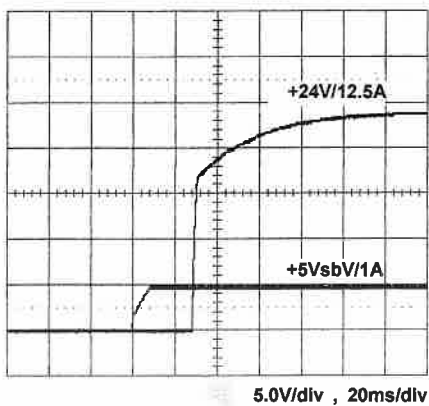

8.4 Output turn off wave form

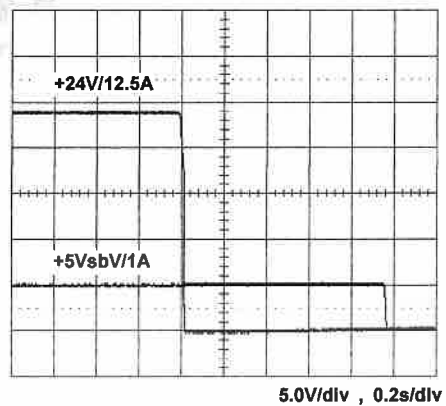

8.5 Hold-up time

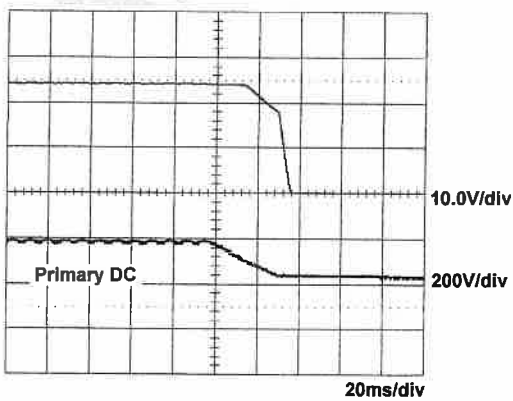

8.6 Over voltage protection

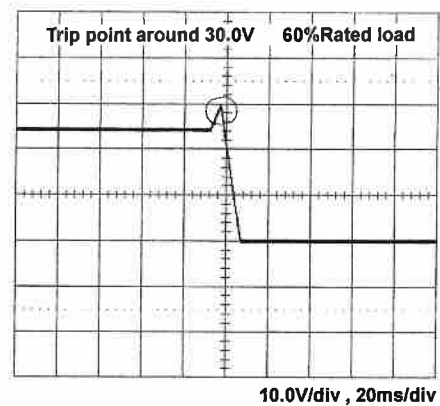

8.7 +5Vsb Over voltage protection

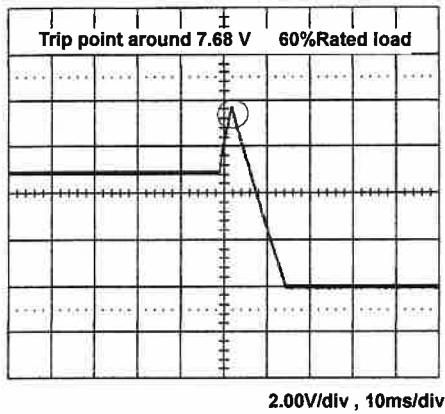

8.8 +24V Step response

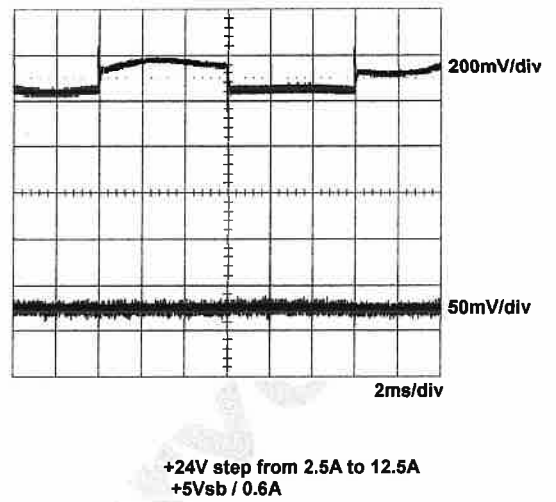

8.9 Peak Load

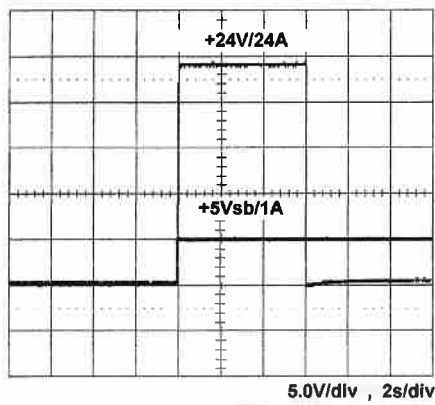

8.10 High torque capability

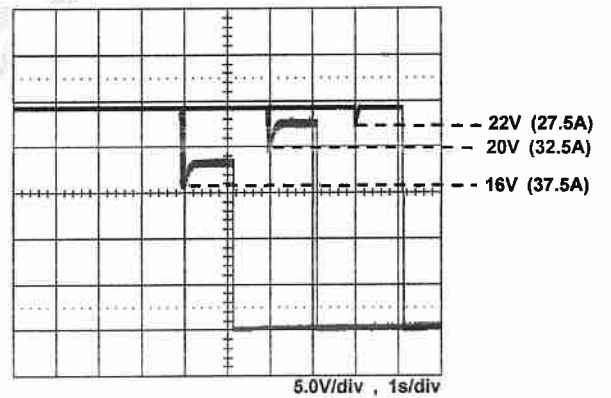

8.11 Remote ON / OFF

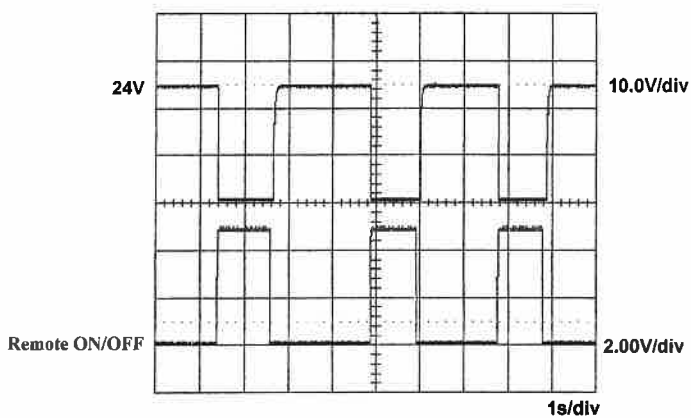

8.12 FCC B QP performance

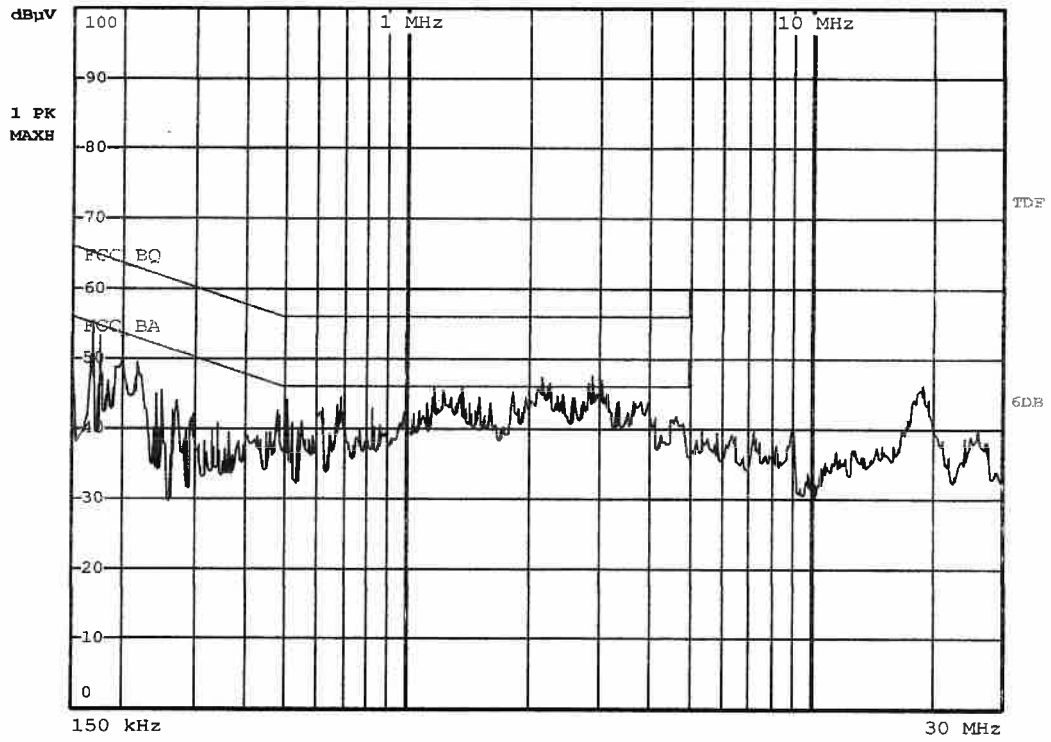

8.13 EN55011 22 "B" QP performance

